



City-Wide Streetscape Implementation Manual and Financial Strategy

For Intensification Areas and Heritage Conservation Districts



November 2014



THIS PAGE IS INTENTIONALLY LEFT BLANK

Acknowledgements

The Vaughan City-Wide Streetscape Implementation Manual and Financial Strategy is a cross-disciplinary collaboration of the City of Vaughan, Sierra Planning and Management, Brad Golden & Co., Planning Solutions Inc., Gabriel Mackinnon, Genivar Ontario Inc., and EDA Collaborative Inc. The leadership, support, enthusiasm and expertise demonstrated by all those involved have been invaluable during this innovative process. This guide is a result of their dedication to building a better Vaughan.

Planning

Development Planning
Urban Design and Cultural Heritage

Engineering and Public Works

Engineering Services
Public Works
Development Transportation
Parks Operations and Forestry

Finance

Development Finance & Investments
Budgeting and Financial Planning

Stakeholders

The City of Vaughan and the design team would like to thank all the stakeholders involved in the process for their invaluable input and support including The Regional Municipality of York and Building Industry and Land Development Association (BILD).

Consultant Team

Sierra Planning and Management
EDA Collaborative Inc.

With Input From

Brad Golden & Co.
Planning Solutions Inc.
Gabriel Mackinnon
Genivar Ontario Inc.







Section 1 Introduction	7
Section 2 Purpose	11
Section 3 The Role of Streets in a City	17
Section 4 Policy Framework	23
Section 5 Process	27
Section 6 Design Strategy	31
Section 7 Implementation	139
Appendix A	187
Appendix B	195
Appendix C	197
Appendix D	201
Appendix E	211
Appendix F	219
Appendix G	223
Appendix H	227
Appendix I	231
Appendix J	233



Table of Contents

Section 1 Introduction			
Introduction		9	
Section 2 Purpose			
Purpose		13	
Where does this apply		14	
Section 3 The Role of Streets in a City			
The Role of Streets in a City		20	
Section 4 Policy Framework			
Relevant Policy		25	
Section 5 Process			
Process		29	
Section 6 Design Strategy			
Design Strategy		33	
Decision Making Matrix		37	
The Road Classification		38	
Streetscape Zones		43	
Streetscape Types		49	
Level of Service		53	
Design Components		71	
Design Components Matrix		72	
Design Components for Enhanced and Premium Streets without Master Plan Designs		74	
Typical Paving Pattern		76	
Paving		81	
Illumination Elements		85	
Planting		89	
Site Furnishings		96	
Medians		100	
Intersections		107	
Public / Private Frontage		121	
Utilities		123	
Innovation		128	
Section 7 Implementation			
Implementation		141	
The Model		145	
Financial Strategy		159	
Intensification Projects		170	
Developer Impact		179	
Priority Implementation Streets		181	
Appendix A			
Level of Service			
Typical Cross Section Construction			189
Appendix B			
Region of York			
Top Performing Street Tree Species			196
Appendix C			
Region of York Notable Street Tree Species for Select Planting Sites			198
Appendix D			
City of Vaughan			
Tree and Plant Species List			202
Appendix E			
Salt and Drought Tolerant Species List			212
Appendix F			
Streetscape Phasing Option			220
Appendix G			
City Decision Making Matrix			225
Appendix H			
Streetscape Component Selection Matrix			228
Appendix I			
Streetscape Component Breakdown Chart			232
Appendix J			
Operations and Maintenance Assumptions			234

THIS PAGE IS INTENTIONALLY LEFT BLANK

INTRODUCTION



Introduction

“A **Complete Street** is designed for all ages, abilities, and modes of travel. On Complete Streets, safe and comfortable access for pedestrians, bicycles, transit users and the mobility-impaired is not an afterthought, but an **integral planning feature.**”

- *Complete Streets for Canada*

Vaughan is in the midst of an exciting and transformative era of the City’s development with rapid urbanization and expansion of public transit. The City’s Official Plan includes the designation of Intensification Areas and Heritage Conservation Districts. The appearance and character of streets in these areas will play a large part in determining the overall quality and livability of our city.

The streetscape standard for our emerging urban areas and established Heritage Conservation Districts must be oriented towards active transportation and be financially sustainable to advance the goals outlined in the Official Plan:

- Strong and Diverse Communities
- A Robust and Prominent Countryside
- A Diverse Economy
- A Vibrant and Thriving Downtown
- Moving Around without a Car
- Design Excellence and Memorable Places
- A Green and Sustainable City
- Directing Growth to Appropriate Locations

Complete Streets are designed to support active transportation, the environment, commerce, culture, and every day life for people of all ages and abilities. The limits of the defined “streetscape” for the purpose of this manual are from curb to building frontage. However, it is important to note that for the design of a Complete Street, the City will consider the street as a whole in order to effectively capture all considerations and opportunities.

While the transformation will be incremental and extend over many years, this manual provides an excellent opportunity for Vaughan to show its commitment to the development of a great public realm. It is the aim of the City-Wide Streetscape Implementation Manual and Financial Strategy to be a tool to help guide streetscape development and investment while outlining a consistent and comprehensive approach to streetscape design.

THIS PAGE IS INTENTIONALLY LEFT BLANK

PURPOSE



Purpose

The Streetscape Manual aims to be **flexible** and **encourage innovative design**.

The City-Wide Streetscape Implementation Manual and Financial Strategy (Streetscape Manual) provides an integrated design and financial framework to manage the design and costing of streetscapes in Intensification Areas and Heritage Conservation Districts in the City of Vaughan.

The Streetscape Manual is a reference tool developed to guide the design and construction of urban streetscapes in Vaughan with consideration of maintenance and operations. The Manual emphasizes the design of the pedestrian realm in an urban context.

Support Active Transportation

The manual aims to develop streetscapes which are alive with all modes of active transportation (walking, cycling and transit) to support happy and healthy lifestyles. Incorporating facilities and amenities to support active transportation modes is an important consideration in the design of the streetscape. For example, locating bike parking at nodes and key locations within the amenity zone; providing a comfortable pedestrian realm through the use of trees for shade, seating, waste and recycling receptacles, and streetscape planters for protection from the vehicular roadway; and, strategically locating transit shelters to allow for adequate pedestrian circulation and access.

Provide and Maintain a Consistent Quality of Design

The Vaughan City-Wide Streetscape Implementation Manual is a design guide that incorporates current best practices in streetscape design. The manual also outlines a process for city staff and developers to ensure there is a common understanding and facilitated transition between master planning and detailed design.

Design Appropriate Streets to Context

The manual provides guidance to ensure that the appropriate design solution is applied to the streetscape context. As Vaughan transitions from suburban areas to urban intensification areas, the manual serves as a guide to ensure that the existing suburban streetscape standard is not simply transferred to new intensified urban areas. A new urban streetscape standard has been created through this Study to leverage opportunities for streetscapes in Intensification Areas and Heritage Conservation Districts. In Heritage Conservation Districts, streets are designed to respect and complement the identified character of the district as described in the Heritage Conservation District Plan. As public spaces, streets contribute to the contemporary economic, cultural and social life of the District.

Support City Building

City building is a combination of social, environmental, cultural and economic factors. The implementation manual provides a framework to consider all four factors in streetscape design to ensure informed decisions by decision makers.

Inform Budgeting and Financial Resources

The Financial Strategy combines context, design and cost together to forecast potential financial commitments and consider potential funding.

Where does this apply

The Vaughan City-Wide Streetscape Implementation Manual applies to all Intensification Areas and Heritage Conservation Districts in Vaughan.

Intensification Areas

The City of Vaughan Official Plan directs growth to appropriate areas that can support it, including the promotion of Intensification Areas in the city. The Intensification Areas are classified as the Vaughan Metropolitan Centre, Primary Centres, Local Centres and Primary Intensification Corridors.

Heritage Conservation Districts

Vaughan's Heritage Conservation Districts include the historic villages of Kleinburg-Nashville, Maple, Woodbridge and Thornhill. The Official Plan recognizes and conserves cultural heritage resources and promotes the maintenance and development of an appropriate setting within, around and adjacent to all such resources.

Heritage Conservation Districts are established to conserve existing heritage resources and streetscapes and guide future development. The social, environmental and economic benefits of the streetscapes and character of a Heritage Conservation District are greater than any single heritage building. For this reason, Heritage Conservation Districts are distinct from other areas in Vaughan and seek to attract citizens and visitors to live, work, and recreate.

The role of the streetscape in a Heritage Conservation District is to support landscape and built form character, support viable social and economic use, and to increase awareness of the cultural heritage and its significance.

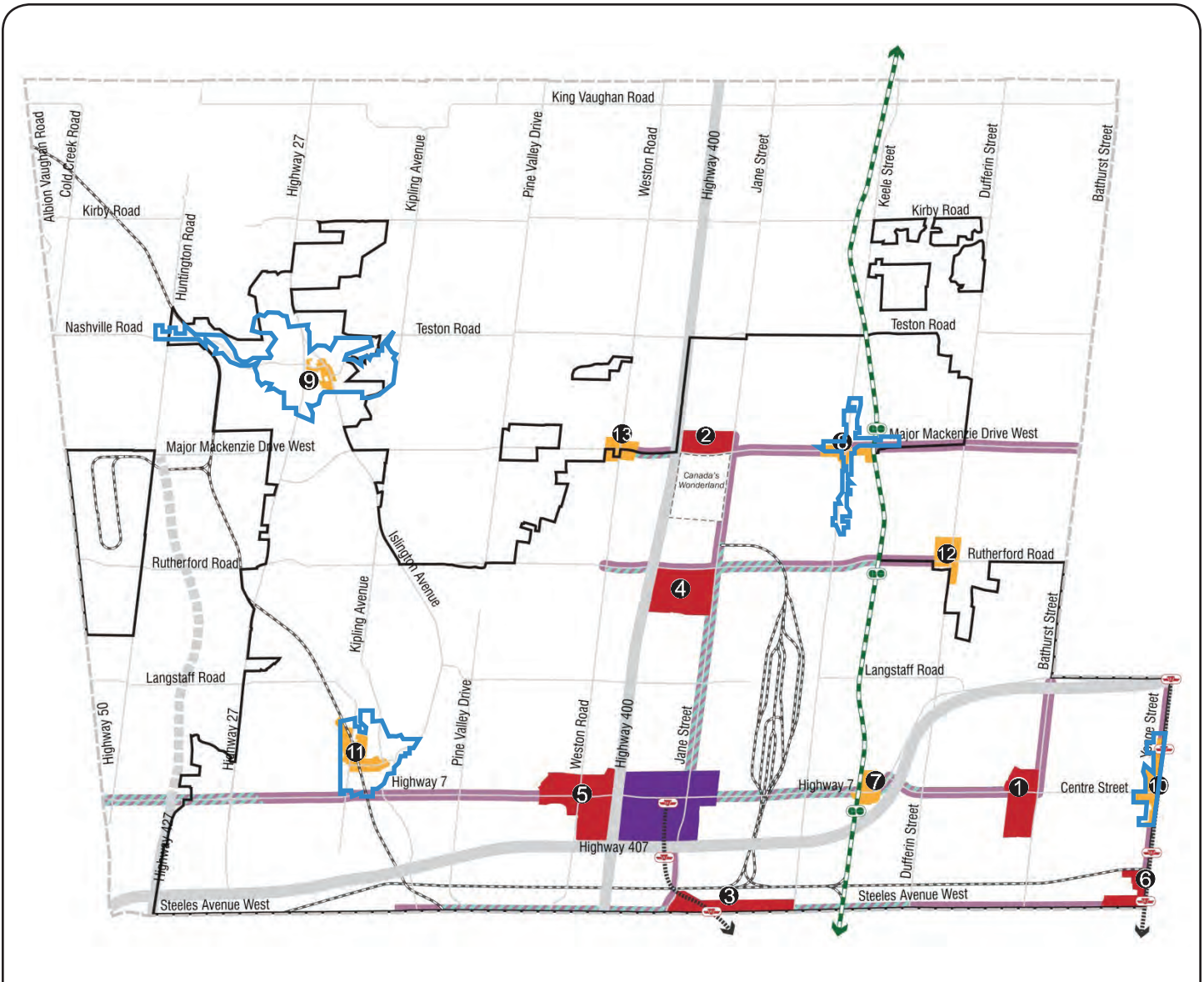

Vaughan Metropolitan Centre	Primary Centres	Local Centres	Primary Intensification Corridors
	1 Bathurst & Centre St.	7 Concord Centre	Regional:
	2 Jane St. Major Mackenzie Dr.	8 Historic Maple Village	
	3 Steeles West	9 Historic Kleinburg Village	• Yonge
	4 Vaughan Mills	10 Historic Thornhill Village	Local:
	5 Weston Rd. & Highway 7	11 Historic Woodbridge Village	• Jane Street
	6 Yonge St. & Steeles Ave.	12 Carrville Centre	• Major Mackenzie Drive
		13 Vellore Centre	• Rutherford Road
			• Steeles Avenue

Figure 2.1: Intensification Areas
City of Vaughan Official Plan 2010 (as approved February 3, 2014)

THIS PAGE IS INTENTIONALLY LEFT BLANK

THE ROLE OF STREETS IN A CITY





The Role of Streets in a City

Streetscapes as Infrastructure

Streets are infrastructure that contain opportunities to serve multiple functions and types of users including public space, pedestrian and bicycle mobility and access, stormwater capture and/or filtration, air quality improvement, temporary or permanent art placement, community character, as well as support for many social and business activities, depending on community priorities.

Street trees and planting are often associated with streetscape beautification. However, street trees and planting have other functions including reducing the heat island effect, stormwater management, creating oxygen, barrier protection from vehicles, and protection for pedestrians from the elements including rain, wind and sun. Ecosystem services provided are closely tied to canopy size and therefore planting conditions and techniques should be considered to promote the growth of trees to maturity.

Streets play a significant role in the vitality, livability and character of a city or neighbourhood. Streets are urban spaces where the daily activities of a city take place. The design of these spaces is an essential element in achieving a vibrant, comfortable and sustainable city.

Streetscapes also provide one of the most essential spaces for public interaction. The comfort of an individual in a space affects their willingness and ability to interact with a fellow individual. Therefore, to foster great communities, the pedestrian experience is paramount.

Community Identity, Wayfinding and Branding

The streetscape is the first public element in forming an individual's impression of a neighbourhood. Streetscapes are imperative in forming the favourable first impression needed to attract and retain residents and businesses.

Growth and Development

Streetscapes support growth in City development. Seven of the eight goals in the Official Plan are supported by Complete Streets including Goal 3: a diverse economy and Goal 4: a vibrant and thriving downtown. The City of Vaughan is an attractive place for private investment, and will enhance its reputation by leaving a memorable impression on individuals. Growth and development in Vaughan is supported by sustainable infrastructure investment.

Economic Development

Benefits of streetscape investment include economic development, enhanced value of surrounding lands, quality of place and city building. Streetscape investment also leads to growth in pedestrian traffic, retail sales, achievable rents and area demand.

Seven goals in the Official Plan are supported by Complete Streets

Planning Efficiency and Consistency

There is a need to clearly define and integrate multidisciplinary streetscape planning, design and financing process. At present, the cost estimates in streetscape master plans can vary widely due to a number of factors, including:

- Assumptions
- Methods
- Components
- Materials
- Unit costs
- No operations and maintenance or life cycle costs included

The varying practices used in the preparation of cost estimates make it difficult to accurately compare and illustrate the financial implications of streetscape projects among one another and as a result, make it difficult to efficiently implement the projects. A consistent approach to streetscapes from a design and finance perspective provides better input into the planning and budget process and thus more efficiency through implementation. The accuracy and consistency of potential future financial commitments, capital, maintenance and replacement better informs the community on what it is able to fund and willing to pay. Additionally, the consistent design process supports a city-wide identity, branding the City of Vaughan to take advantage of economic development opportunities.

THIS PAGE IS INTENTIONALLY LEFT BLANK

POLICY FRAMEWORK



pur
pur
KICK
ASPARTAME
pur

MILGRO
&
WINTER
GARDENS

100
WINTER GARDEN
FÊTE SES 100 ANS

100
ANNIVERSAIRE

100
ANNIVERSAIRE

100
ANNIVERSAIRE

100
ANNIVERSAIRE

100
ANNIVERSAIRE

100
ANNIVERSAIRE

100
ANNIVERSAIRE

100
ANNIVERSAIRE

100
ANNIVERSAIRE

Policy Framework

Policy at various levels of government cite the need for the public realm to support pedestrian activities and the vital role it plays in healthy and active communities.

Provincial Policy

Healthy, active communities should be promoted by: Planning public streets, spaces and facilities to be safe, meet the needs of pedestrians, foster social interaction and facilitate active transportation and community connectivity (*PPS Policy 1.5.1.a*).

Planning authorities should promote green infrastructure to complement infrastructure (*PPS Policy 1.6.2*).

Regional Policy

To require high-quality urban design and pedestrian-friendly communities that provide safety, comfort and mobility so that residents can walk to meet their daily needs (*The Regional Official Plan, Section 3.1 Human Health and Well-Being*).

Municipal Policy

Great cities can all boast of a vibrant public realm. Vaughan is committed to building a truly remarkable public realm throughout the City (*City of Vaughan Official Plan, Elements of a Great City 9.1.1*).

The primary consideration for enhancements to the street network are to support transit and rapid transit, cycling, walking and other alternatives to automobile use (*City of Vaughan Official Plan, Street Construction, Improvements and Maintenance 4.2.1.29*).

THIS PAGE IS INTENTIONALLY LEFT BLANK

PROCESS



Process

To develop the Vaughan City-Wide Streetscape Implementation Manual in a well-researched manner, the project was divided into three phases.

Phase 1 – Project Assessment of Existing Conditions

Phase 1 focused on defining the existing service level for streetscape maintenance and operations to create a baseline for Vaughan. The baseline was important to understand the true financial implications of streetscape enhancements during the decision making process.

Phase 2 – Research and Conceptual Approach

During Phase 2 it was important to research the possibilities and lessons learned from other municipalities. This ensured that the manual was versatile enough to address a variety of possible future development scenarios. Based upon the research, both a design framework and cost framework were developed. The frameworks were tied together with a design / cost element which lead to a conceptual design and financial strategy. The concept was to create a streetscape design process with a holistic approach.

Phase 3 – Standards, Strategies and Finalization

The final phase was the development of the streetscape manual and finalizing the design and financial strategies. The streetscape manual is a set of best practices for streetscape components building upon the details of the streetscape structure, and design framework.

THIS PAGE IS INTENTIONALLY LEFT BLANK

DESIGN STRATEGY



Design Strategy

Context Sensitive Design

The structuring elements of streetscapes for the City of Vaughan are road classification, streetscape type and level of service. These elements are useful tools for the design of streets that respond both to the local context and the context of the greater regional area. It is important that the streetscape is designed with consideration of the context of the street in the overall street network, the function of the roadway, the functions within the pedestrian boulevard, the adjacent land uses, and the future development of the area.

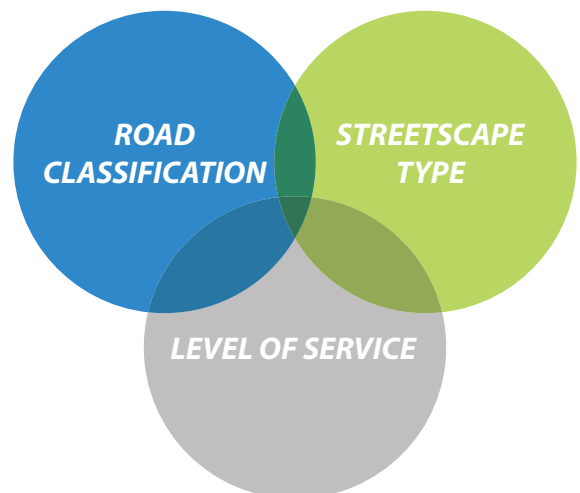

The Vaughan City-Wide Streetscape Implementation Manual provides two integrated strategies:

- [Design Strategy](#)
- [Financial Strategy](#)

The integration between the Design Strategy and the Financial Strategy occurs through the level of service concept and allows for design and cost to work together simultaneously. The combination of the design and financial strategies help to create a financial forecast that is holistic in considering both appropriate design for context and cost.

Design Strategy

The Design Strategy provides a framework for a comprehensive and common streetscape language that can be applied in the Intensification Areas and Heritage Conservation Districts. The Design Strategy is a tool and process to ensure that future intensified urban streetscapes in Vaughan are designed to a common standard with respect to context, design and cost. The key elements of the Design Strategy include road classification, streetscape zones, streetscape types and level of service. These elements address concerns of context, appropriate design response, design quality, character and cost. The aim of the Design Strategy is to consolidate the design process so that designers, developers and the City are able to coordinate on streetscape design functionality, appropriateness and quality.

Financial Strategy

The Financial Strategy provides a tool at the early stages of master planning to forecast financial commitments based upon certain assumptions. The Financial Strategy is a combination of three elements: design, phasing and funding, and shares the level of service concept with the design strategy as a common language. The phasing element considers the timing characteristics of individual master plan projects. The funding element deals with financial and funding processes.

A key part of the Financial Strategy and funding element is the financial model. The model is a decision making tool which takes key design information from master plans and the City-Wide Streetscape Design Strategy and translates the information through financial processes to forecast financial commitments and funding. The results of the model allow for designers and the City to adjust master plans at the early stages in response to the financial impact results from the model. The combination of design, phasing and funding inform the financial forecast which can be used to inform Council in the early stages of master plan projects.

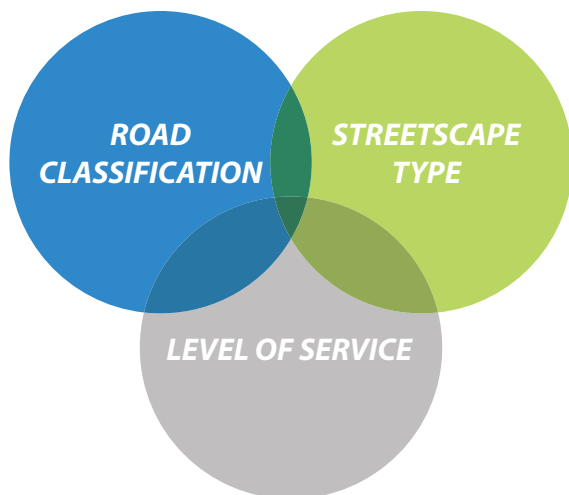

Figure 6.1: Streetscape Structuring Elements

There are three structuring elements to streetscapes in Vaughan:

- Road Classification
- Streetscape Type
- Level of Service

Road classification and the streetscape type define streets in the high level planning and land use planning context. In the past, level of service was associated with the roadway and vehicular traffic, simply considering the ability of a roadway to effectively move traffic flow and meet transportation needs. Complete streets encompass the entire streetscape and all modes of transportation, including equal consideration for cyclists and pedestrians. The Streetscape Manual applies a level of service concept to the pedestrian boulevard design which responds to the context and functional needs of a street for all modes of transportation. For example, on streets with pick-up / drop-off zones the pedestrian boulevard must be designed to safely interface with idle zones, cycle facilities and ensure the safety of the pedestrians from the adjacent land uses. The pedestrian boulevard is designed as the common element connecting adjacent land uses and the roadway while serving the complete street.

The streetscape level of service is focused on the pedestrian boulevard and the pedestrian experience relative to the road classification and streetscape type. With these in mind, level of service goes on to further consider the economic aspect of streetscapes. Capital costs and potential funding for streetscapes are important to understand from an implementation point of view. Even more important is the future year-to-year financial commitment of a municipality for operations and maintenance costs. Consequently, the level of service concept aids as a tool to understand streetscapes from the functional, design and economic perspectives.

It is important to note that cycling infrastructure is an equal and important part of a Complete Street. Because raised cycle tracks and bike lanes are considered part of the roadway design, their details are not detailed in this version of the Streetscape Implementation Manual.

York Region

York Region's Centres and Corridors Program is an integrated approach that combines the planning of urban pedestrian-friendly / walkable and bikable communities with the construction of new rapid transit lines and stations.

York Region is currently developing a Context Sensitive Solutions (CSS) design approach to street design with the following goal: "To create vibrant streets for York Region that provide a range of safe and reliable transportation options while being sensitive to the adjacent land uses and the needs of the community." The Region's CSS Guiding Principles are:

1. Tailor solutions to fit the context
2. Tailor the process to reflect the transitioning role of the road
3. Plan projects in collaboration with the local community
4. Plan for multiple transportation modes to promote sustainable, flexible solutions
5. Use sound professional judgement to determine priorities for the road design

Strategy Decision Making Matrix

As a tool to provide information for more informed decisions, the Vaughan City-Wide Streetscape Implementation Manual identifies important decision points for the City over the process of streetscape implementation. A more detailed decision making matrix can be found in Appendix A.

Master Plan Identification

The decision to go forward with a master plan is a question of commitment. The City needs to decide if the master plan area requires investment in enhanced streetscapes based upon questions such as projected population growth, economic development potential, and whether the area is an Intensification Area or Heritage Conservation District as identified in the Official Plan. Alternatively, Business Improvement Areas may instigate and fund streetscape plans in consultation with the city.

Master Plan Financial Commitments

As a master plan progresses, the City will face the initial questions of capital and maintenance affordability. The level of service concept helps the City to determine what level of design is appropriate and the financial model helps to determine the potential financial commitments.

Funding and Negotiations

To facilitate coordination, it is useful to start negotiations regarding potential funding partners early in the master plan process. Potential partners could include York Region, developers, other municipalities, and transit agencies such as the TTC and vivaNext.

Project Details

Only after some potential certainty of funding and affordability will the detailed design of a streetscape project be undertaken. The detailed design of the project offers an accurate costing based upon an appropriate design decided by the level of service.

Value Engineering

Value engineering is a question of value for investment and efficiency. Are there ways to cut costs while maintaining the integrity of the design?

Proceed to Construction

With knowledge that the financial commitments and design meet the needs of the municipality the City may approve and proceed with the construction.

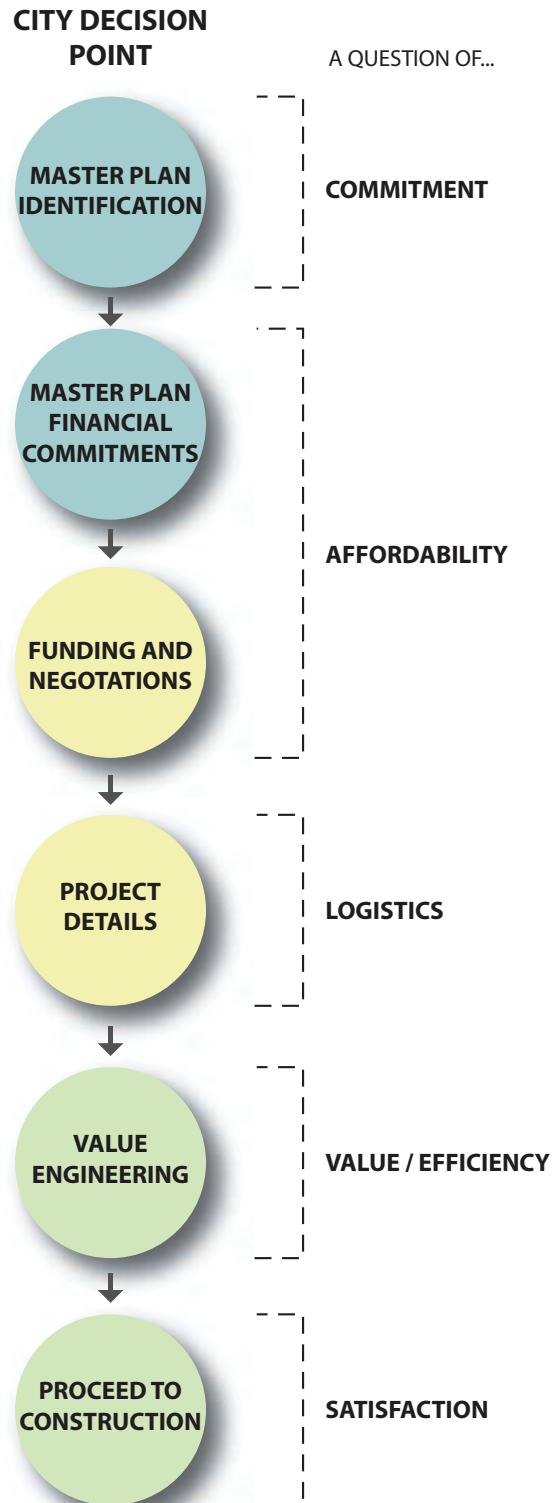

Figure 6.2: Strategy Decision Making Matrix

The Road Classification

Strategy I

The engineering road classification establishes the role of the street in the overall road transportation network of a city and region. The structure of the roadway (for example the number of traffic lanes) has prioritized vehicular functions since the dominance of the automobile from the 1920s and 1930s. Today, there is a movement towards the equal inclusion of cyclists and pedestrians within the right of way given the problems of traffic congestion and pollution. Hand in hand with this shift in attitude is the growing recognition that city streets are public places for people. The function of the roadway plays a large part in the experience of pedestrians in the streetscape. The type and ownership of streets in the overall road classification also affects the potential funding options available.

Ownership

Streets in Vaughan are either regionally or municipally owned. While most streets are municipally owned, there are examples of streets owned by the Region which play an important part in the overall connectivity of the street network. Major arterials are regionally owned while minor arterials, collectors and local streets are municipally owned. On all roads (including regional roads), the City of Vaughan has jurisdiction over pedestrian sidewalks (the pedestrian clearway).

Road Classification

The road classification in Vaughan is comprised of four types of streets with five sub-categories. These include:

Arterials

- Major Arterial - Typ. 45 m ROW
- Minor Arterial - Typ. 33 - 36 m ROW

Collectors

- Special Collector - Typ. 33 m ROW (varies)
- Major Collector - Typ. 26 - 33 m ROW
- Minor Collector - Typ. 23 - 26 m ROW

Local Street - Typ. 17.5 - 22 m ROW

Mews - Typ. 15 - 17 m ROW

The function of the roadway plays a part in the experience of pedestrians in the streetscape

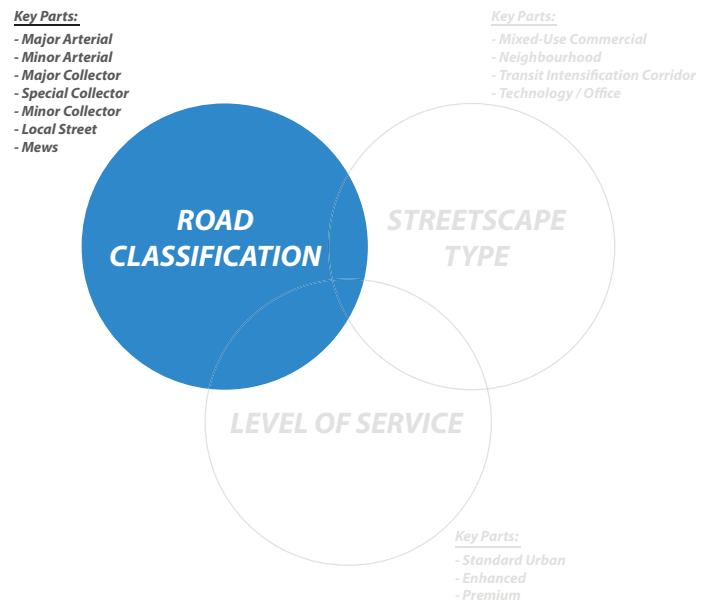

Figure 6.3: Streetscape Structuring Elements - Road Classification

Arterials

Arterials are large streets that focus on the movement of mixed traffic (transit, vehicles, cyclists and pedestrians) at the regional and city-wide scale. These streets facilitate higher traffic speeds for longer trips, regional public transportation, and the transportation of goods. Arterials are subdivided into two categories: major and minor. Major Arterials are owned and operated by York Region. Minor Arterials are municipally-owned.

York Region's is currently developing a Context Sensitive design approach to design to complete street standards and guidelines that are sensitive to the context in which the streets exist. The Region's most urbanized areas, including the City of Vaughan's Urban Intensification Areas, prioritize active transportation and public transit.

Collectors

Collectors are medium-sized municipal streets that connect the arterial street network to the local street network. Collectors are characterized by a balance of vehicular and cycling movement and pedestrian activity. The three categories of Collectors are: Major, Minor and Special. Special Collectors are feature destination streets surrounded by pedestrian activity-generating land uses, and subsequently, greater emphasis is placed on supporting pedestrian, bicycle and transit activity.

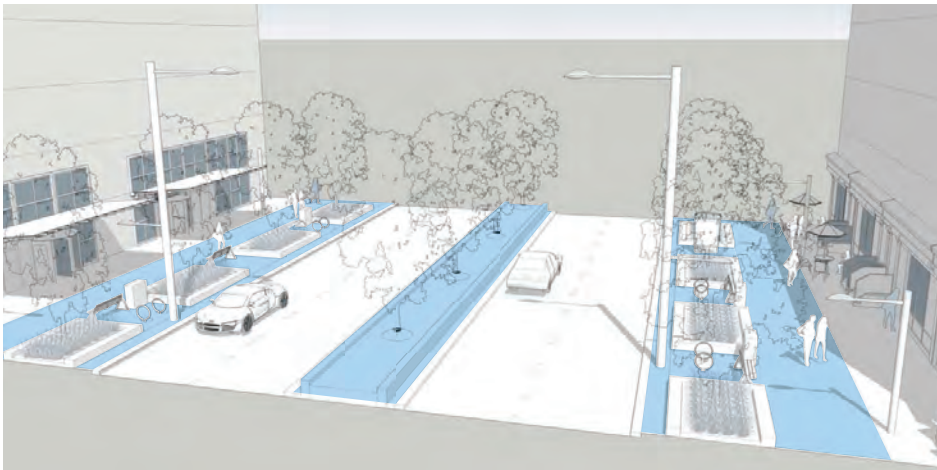

Figure 6.4: Typical Arterial Streetscape



Figure 6.5: Typical Collector Streetscape

Local Streets

Local streets are smaller-scale municipal streets with an emphasis on neighborhood activities and connections. Their intimate scale and slower speed is a comfortable and safe place for pedestrians, cyclists and slow vehicle traffic.

Mews

Mews are small-scale streets that may be pedestrian and cycling only, or pedestrian and cycling-oriented streets that accommodate vehicular laneway functions. In the second option, mews can be designed to balance the servicing and parking access functions of a laneway with active building frontage and generous pedestrian space. Mews contribute to fine-grain connectivity for a greater versatility of movement.



Figure 6.6: Typical Local Streetscape

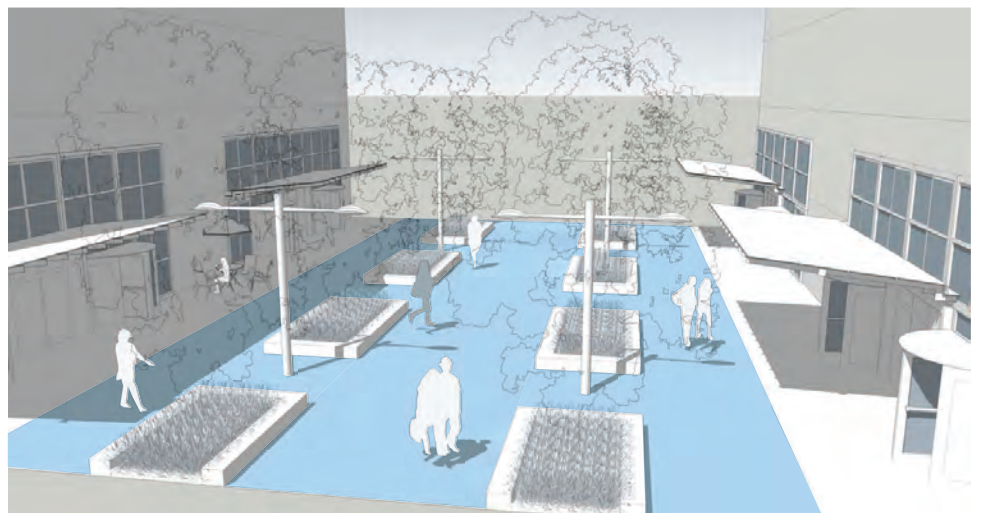

Figure 6.7: Typical Mews Streetscape

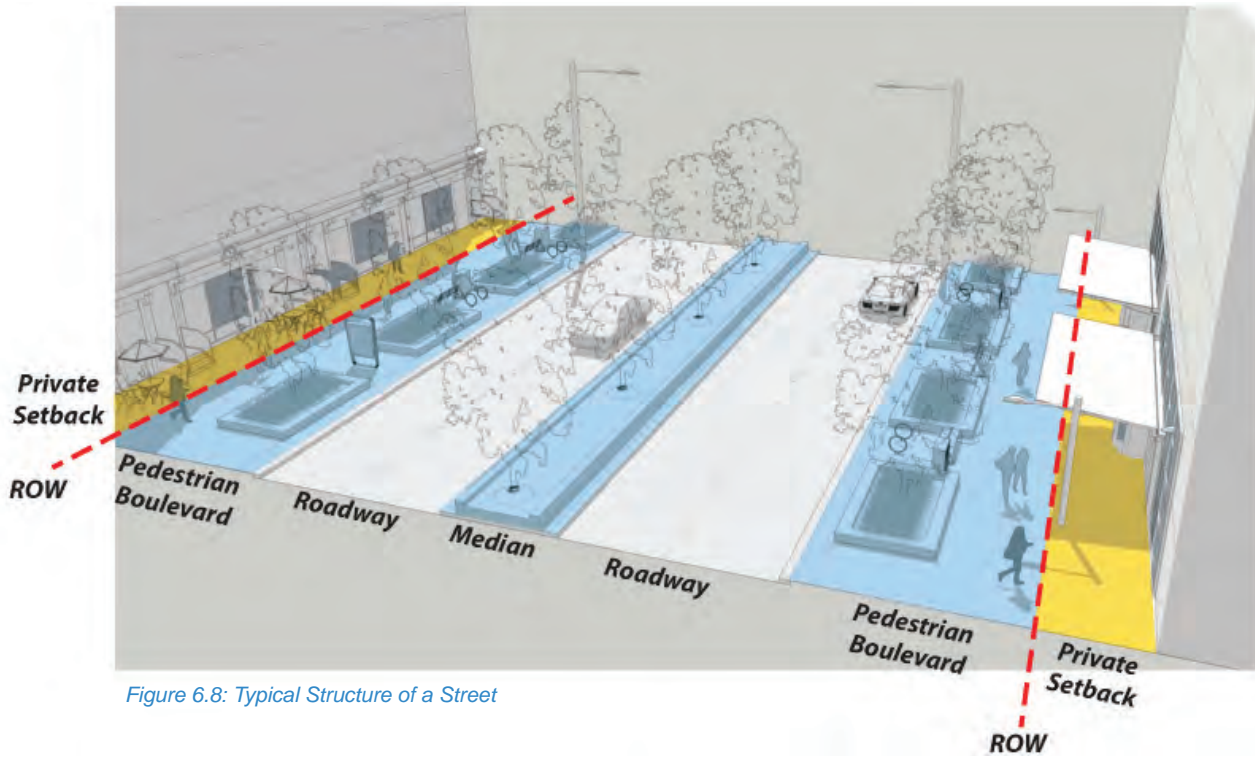

Figure 6.8: Typical Structure of a Street

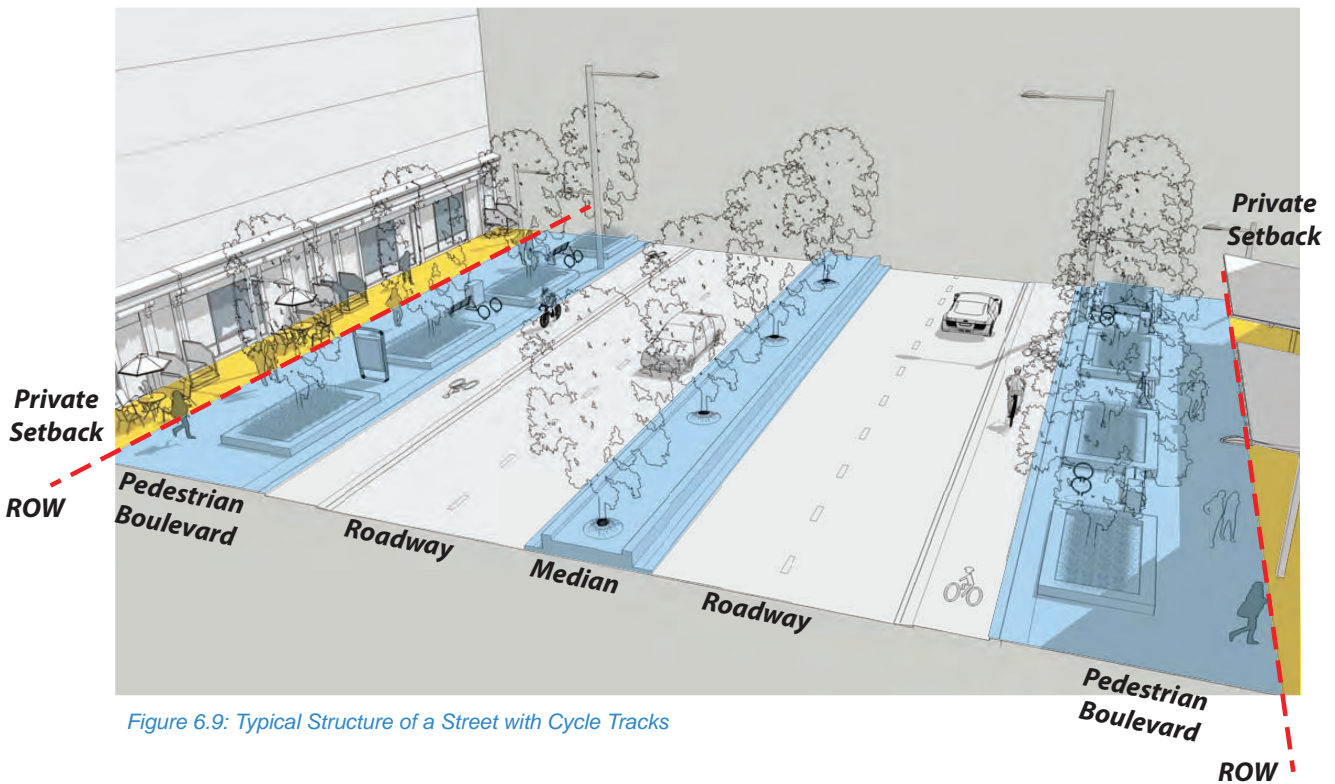

Figure 6.9: Typical Structure of a Street with Cycle Tracks



Streetscape Zones

Strategy II

Streetscape Zones

The streetscape can be separated into five zones. The pedestrian boulevard, typically 5.5 – 6.0 m, contains the frontage zone, the pedestrian clearway zone, the amenity zone and the continuity strip. Where applicable, the streetscape can include the median zone as a fifth zone.

It is useful to consider the streetscape in terms of zones for ease of design. Each zone has typical widths and elements in the streetscape with room for change depending on the needs or functions of the streetscape. Typical streetscape elements can be chosen from the Streetscape Component Selection Matrix (see Appendix H) and placed in their appropriate zone. It is recognized that the Streetscape Component Selection Matrix cannot address every potential streetscape component and zone and it is actually encouraged that special and unique components be explored where applicable for communities with unique character and identity such as Heritage Conservation Districts.

Heritage Conservation Districts and area specific design guidelines are examples of special cases where the structure and components of the Streetscape Manual may differ. Other examples include flexible streets or woonerfs where the pedestrian zone extends into the vehicular traffic area requiring special design treatments and considerations. In areas where the right-of-way is constrained, the continuity strip or frontage zone may be excluded. In other cases, where there is more room allowed in the right-of-way, an additional amenity zone or pedestrian clearway zone may be added to accommodate the use of low impact development measures, an additional row of street trees, or a multi-use track. These zones are typical for streetscapes but they ultimately should not limit the designer.

Other special cases include bump outs at lay-by parking which reduce the roadway. The additional space to the pedestrian boulevard should be used as an amenity zone with potential planting and special paving.

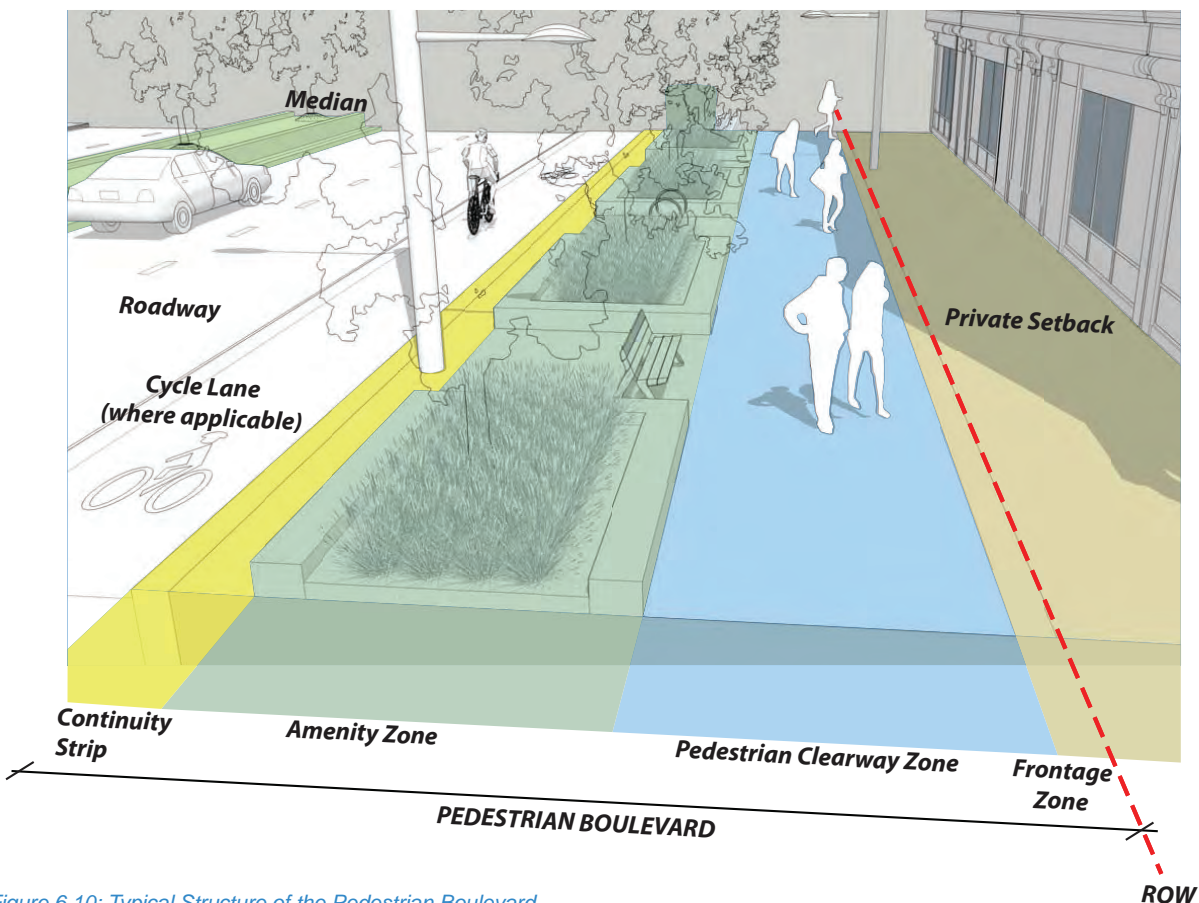

Figure 6.10: Typical Structure of the Pedestrian Boulevard



Seamless Transition across the Frontage Zone

Frontage Zone

Location

The frontage zone is the area between the pedestrian clearway and the street wall.

Description

As the interface between public and private spaces, the frontage zone may be designed as an active zone to encourage seamless movement between the pedestrian sidewalk and building frontage, or landscaped to provide separation and privacy between residential entrances and the street. Hardscape and softscape materials typically utilized include natural stone or concrete unit pavers, poured in place concrete and/or planting.

Function

The frontage zone provides various functions with different material treatments depending on the adjacent land use and space available in the right-of-way. As a semi-transparent barrier for privacy adjacent to residential land use, it may be treated with planting. As an activity or amenity area with street furniture, public art, sidewalk café's and retail displays for typically commercial, retail, restaurant and mixed-uses, the area may be treated with hardscape unit paving, planting, lighting and weather protection.

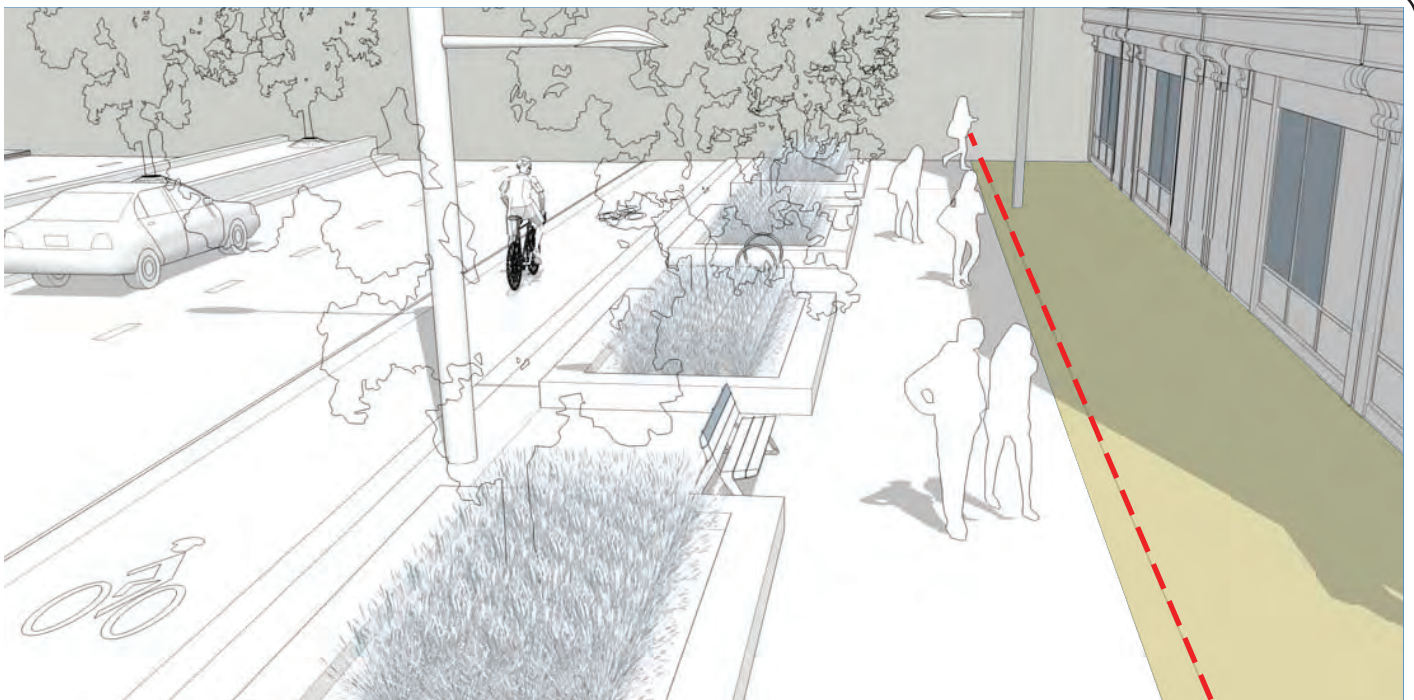

Figure 6.11: Frontage Zone

Pedestrian Clearway Zone

Location

The pedestrian clearway zone is located typically between the amenity zone and the frontage zone.

Description

The main organizing element in the pedestrian boulevard is the pedestrian clearway zone, otherwise known as the sidewalk. The pedestrian clearway zone is typically made up of paving materials such as concrete, unit paving or natural stone.

Function

The function of the pedestrian clearway is to facilitate pedestrian movement and traffic with a path clear of obstructions and obstacles. The pedestrian clearway can be used as a design reference relating to adjacent land uses. For example, retail streets require larger pedestrian clearways to support higher pedestrian volumes and activity. In special cases, the pedestrian clearway zone may be connected seamlessly into public spaces to read as single large spaces.



Pedestrian Clearway Zone with Accent Paving over Amenity Zone

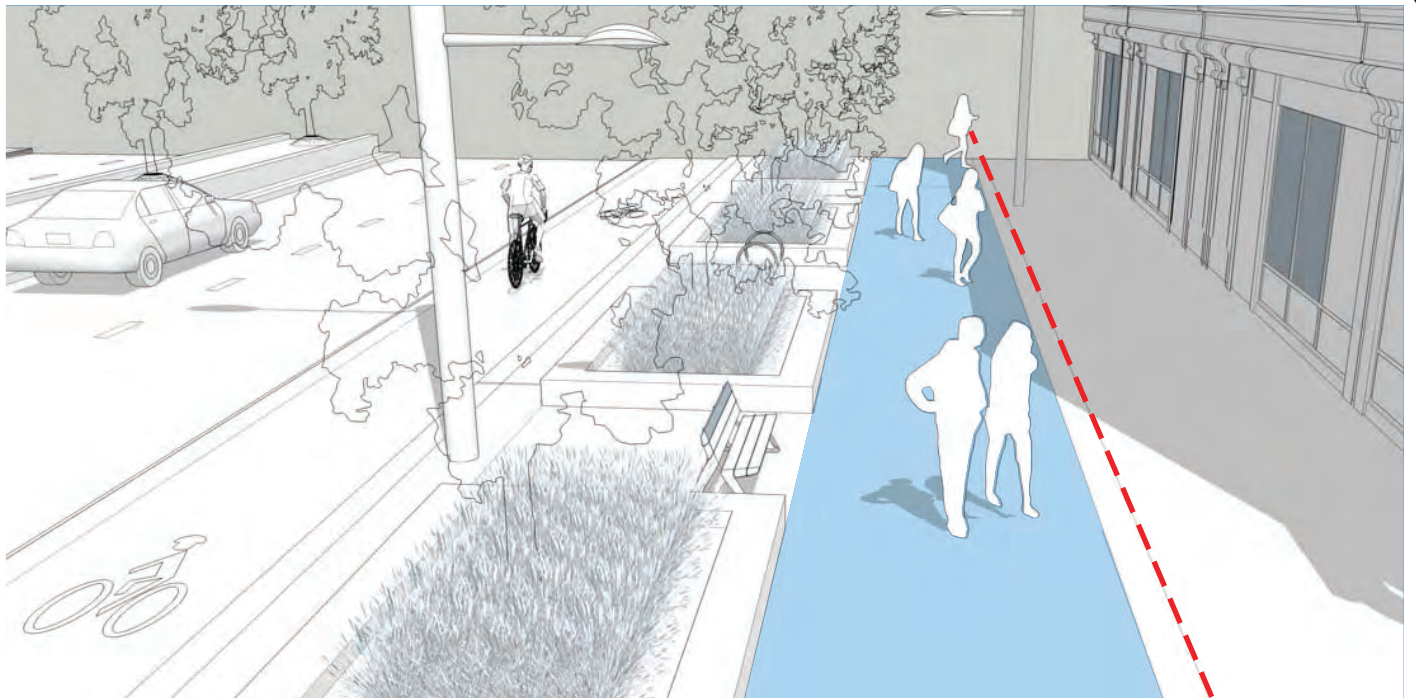

Figure 6.12: Pedestrian Clearway Zone



Amenity Zone

Amenity Zone

Location

The amenity zone is typically located between the pedestrian clearway and the continuity strip zone.

Description

The amenity zone plays a large part in determining the character of the streetscape. The amenity zone may be sodded or paved and may include items such as street trees, street and pedestrian lights, planters, perennials and ornamental grasses, benches, waste receptacles, information kiosks, bicycle stands, and low impact development measures.

Function

The function of the amenity zone is to provide visual, functional, and environmental pedestrian amenities. The amenity zone may also act as a buffer between pedestrians and the vehicular roadway. Specialized streets may also contain additional amenity zones such as green streets with double rows of trees. Additional amenity zones are dependent on right-of-way widths.

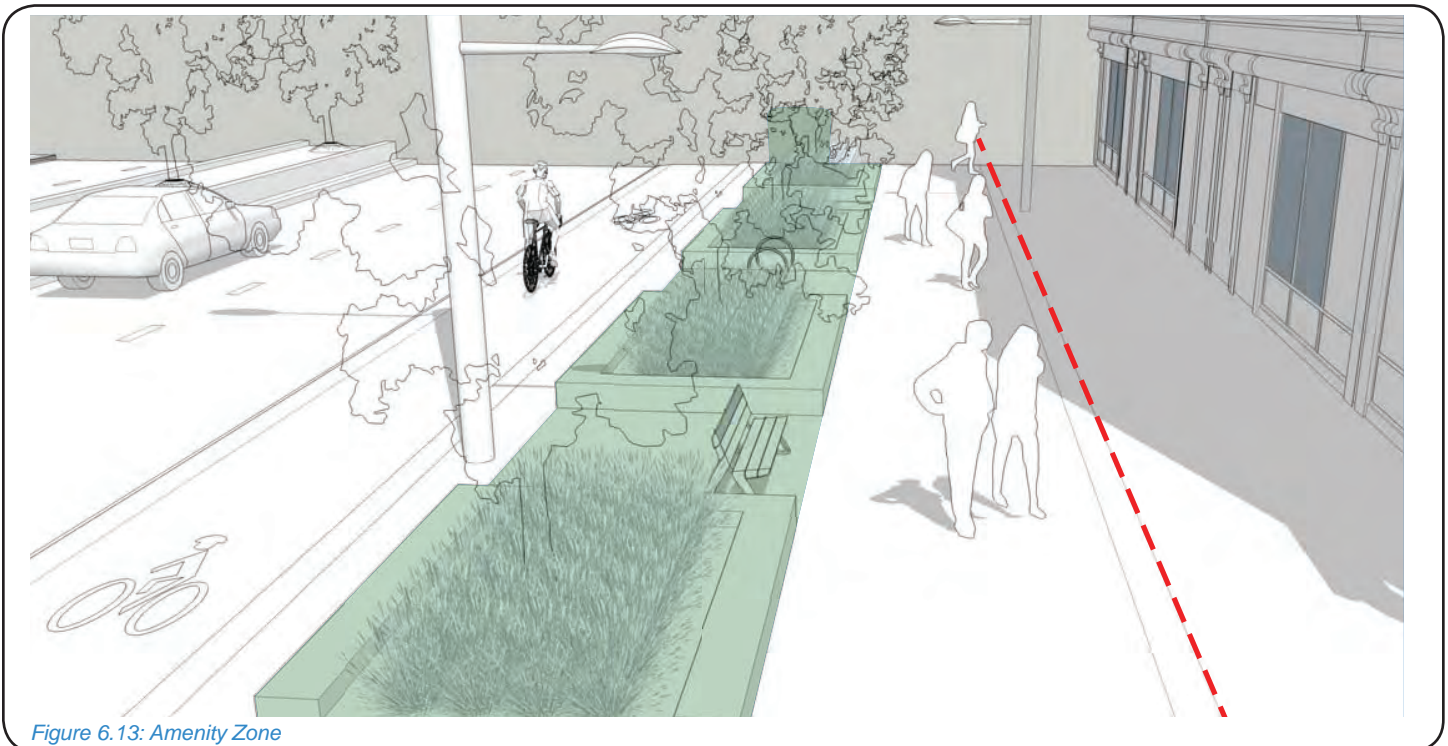

Figure 6.13: Amenity Zone

Continuity Strip Zone

Location

The continuity strip zone is located between the amenity zone and the vehicular roadway.

Description

The continuity strip is a relatively small strip in the pedestrian boulevard and may be treated with softscape (sod) or hardscape (unit paving or poured in place concrete).

Function

Located next to the vehicular roadway, the continuity strip provides a safety clearance for the doors of parked or idling vehicles so they do not interfere with furniture and planters in the amenity zone. The continuity strip provides potential space for street lights, wayfinding signage and utility poles. In addition to the road curb, the continuity strip helps to define the division between the roadway, the pedestrian boulevard, and the rapid clearway (if adjacent to a bike lane on the street), and provides an area for snow storage.



Continuity Strip Zone

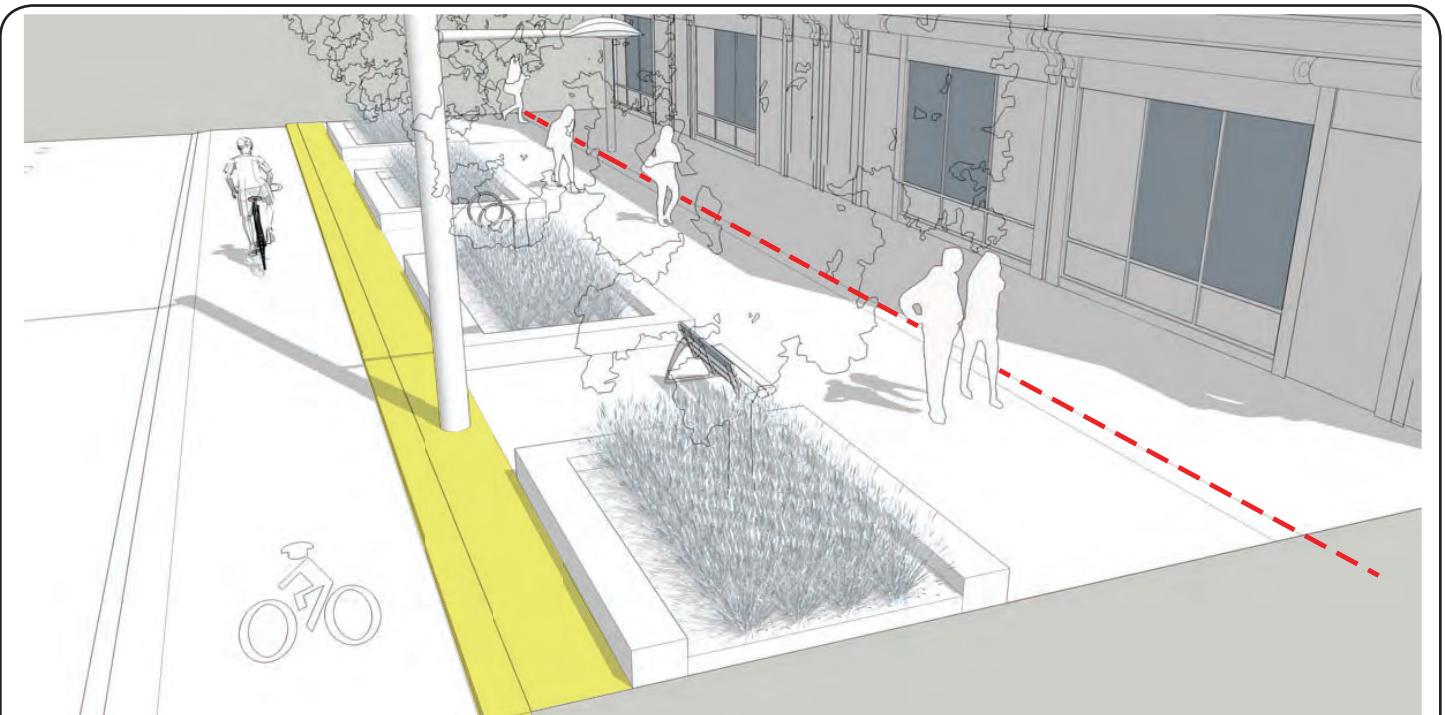

Figure 6.14: Continuity Strip Zone



Median with Seatwall Planter

Median

Location

Medians are located in the middle of the vehicular roadway between opposing traffic directions.

Description

Medians are separate entities from the pedestrian boulevard and typically do not carry pedestrian traffic parallel to the roadway. Medians can come in different forms from thin concrete barriers to wide vegetated areas. In large roadways acting as signature avenues and boulevards of cultural importance, the median may become a large public space with public art, special lighting and seasonal / temporary installations, paving and planting.

Function

The function of the median is to separate vehicular traffic going in opposing directions. For pedestrians, the median provides opportunities for visual stimulation and refuge while crossing particularly large roadways. The median zone can also be utilized as left turn lanes at traffic intersections.

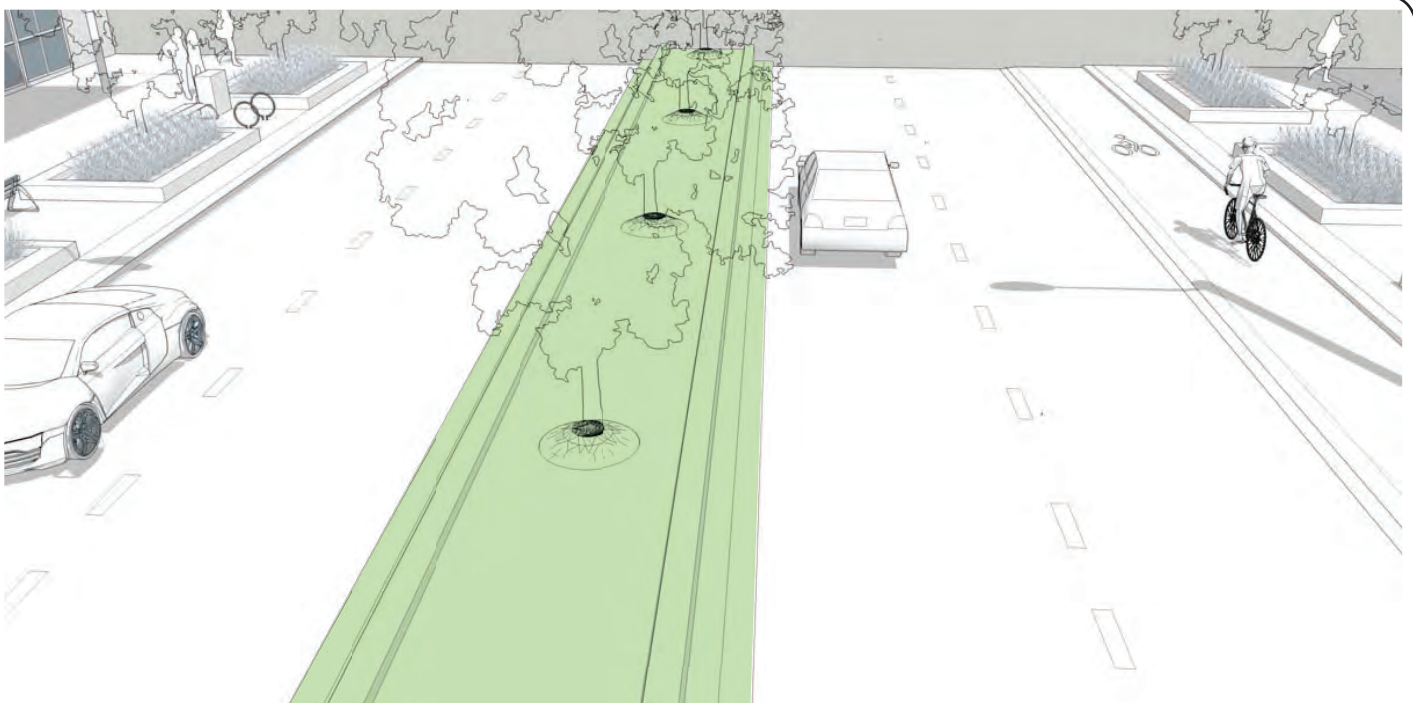

Figure 6.15: Median

Streetscape Types

Strategy III

Streetscape types consider how streets interact with adjacent land uses and context, which influence how a street is used and experienced.

Each streetscape type prioritizes users and various design elements, with pedestrian needs and active transportation as an integral planning feature. The types and spacing of street trees, location, quantity and character of streetscape elements, types of surface treatments, sizes of areas, and lighting all affect the character and experience of a pedestrian within a streetscape. The varying requirements for streetscape components, such as bicycle stands, benches or pedestrian-scale lighting, as well as the width of a sidewalk is influenced by the land uses associated with a streetscape.

Streetscape types may change along the length of a street as surrounding land uses or road functions change.

The streetscape types identified in the City-Wide Streetscape Implementation Manual area:

- [Mixed-Use Commercial](#)
- [Transit Intensification Corridor](#)
- [Technology / Office](#)
- [Neighbourhood](#)

Streetscape types may change along the length of a street as surrounding **land uses or road functions** change

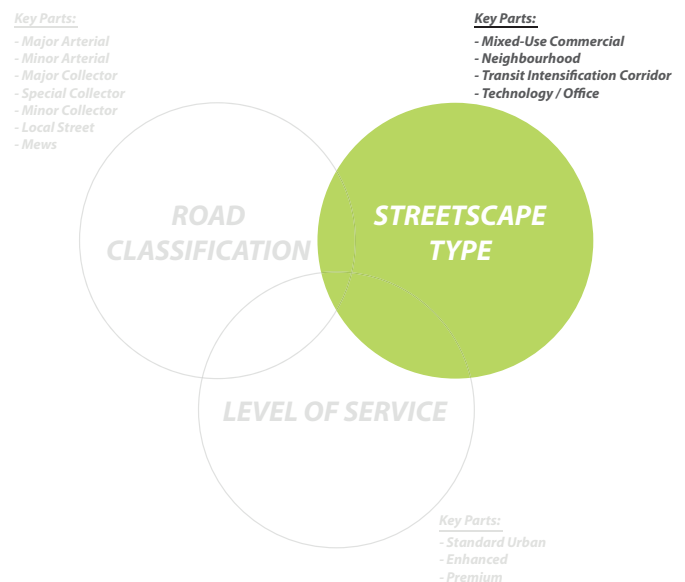
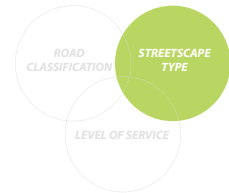

Figure 6.16: Streetscape Structuring Elements - Streetscape Type



Mixed-Use Commercial

Mixed-Use Commercial represents the most active and diverse of the streetscape types applicable to urban scenarios. These streetscape types accommodate higher pedestrian volume, active and transit transportation levels and may include zones which call for specific interaction between the roadway and pedestrian boulevard, including passenger pick-up / drop-off.

Typical Context:

- Mixed-Use
- High Intensity Retail / Commercial
- High Density Residential
- Restaurants & Sidewalk Cafes
- Cultural and Entertainment
- Institutional
- Pick-Up / Drop-Off
- Mews
- Parks & Public Spaces

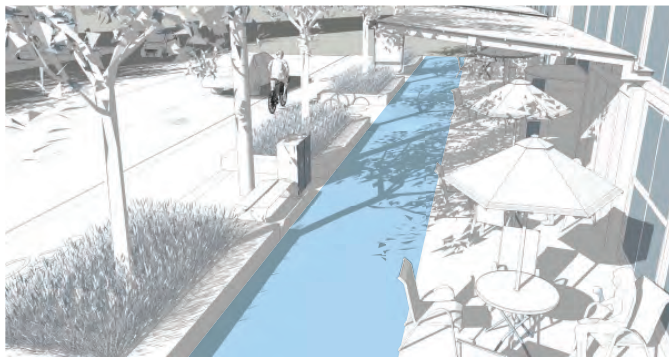

Transit Intensification Corridor

Transit Intensification Corridor streetscape types typically occur along regional arterial roads running through Urban Intensification Areas. These roads serve as regional connections and include transit. Right-of-ways (ROWs) are typically larger along transit intensification corridors and require additional design amenities to protect pedestrians and cyclists from vehicular traffic, vehicular noise and other micro-climate considerations.

Typical Context:

- Retail / Commercial / Office
- Mixed-Use
- High Density Residential
- Parks & Public Spaces
- Mews

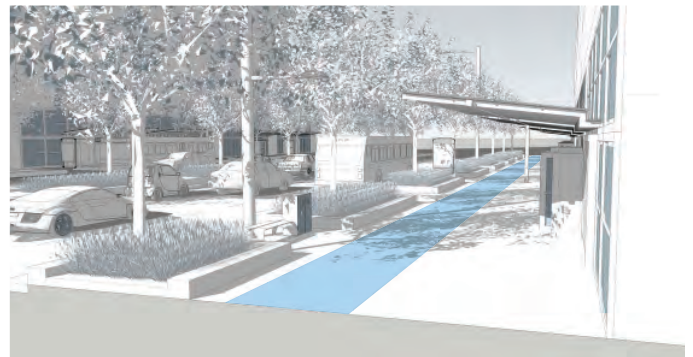

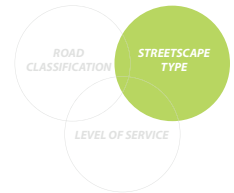

Technology / Office

Technology / Office streetscape types occur in urban employment areas fronting office, technology and commercial land uses. Low to medium pedestrian activity and traffic generally occurs on technology / office streetscapes. Commercial truck traffic may be diverted along these periphery streetscapes in Urban Intensification Areas requiring design provisions to address noise, water and air pollution.

Typical Context:

- Commercial / Office
- Low Intensity Retail
- Employment
- Parks and Public Spaces
- Mews
- Convention Centre / Hotel
- Institutional

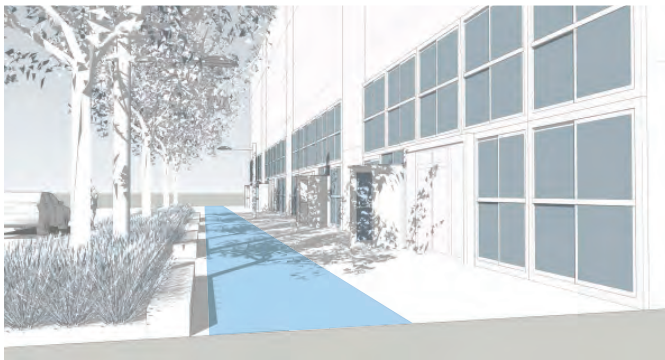

Neighbourhood

Neighbourhood streetscape types primarily front residential land uses and parks. These streetscapes support local pedestrian activity, including children playing, community socializing and are designed to promote walkability. The design focus occurs at the transition across the ROW between the frontage zone and either the private property or public park. While residential streets will provide a semi-public / private transition across the ROW, parks will provide seamless transition between the pedestrian boulevard and the public park.

Typical Context:

- Residential
- Local Retail
- Institutional
- Parks & Public Spaces
- Mews

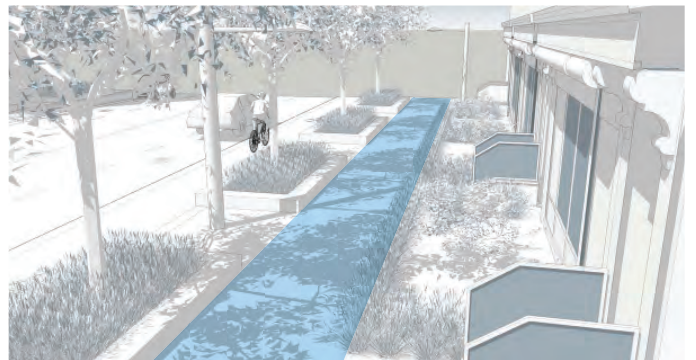



Level of Service

Strategy IV

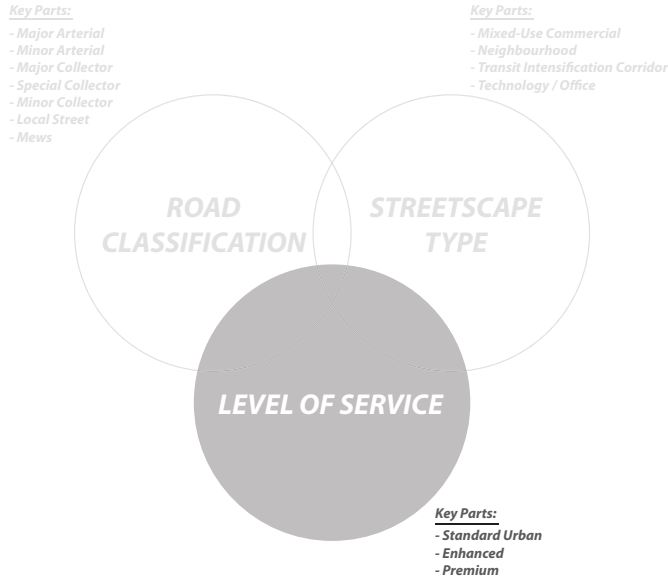
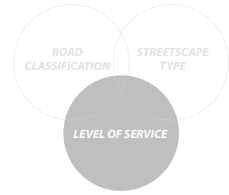

Figure 6.17: Streetscape Structuring Elements - Level of Service

The Streetscape Manual proposed three new levels of service for Vaughan's Intensification Areas and Heritage Conservation Districts: Standard Urban, Enhanced, and Premium.

The streetscape level of service is focused on the pedestrian boulevard and the pedestrian experience relative to the road classification and streetscape type. With these in mind, level of service goes on to further consider the economic aspect of streetscapes. Capital costs and potential funding for streetscapes are important to understand from an implementation point of view. Equally important is the future year-to-year financial commitment of a municipality for operations and maintenance costs. Consequently, the level of service concept aids as a tool to understand streetscapes from the functional, design and economic perspectives.

Each level of service has a corresponding menu of design components from which a designer can choose to customize the streetscape design for community priorities and character. At the same time, the menu of design components streamlines the quantity and types of streetscape materials and elements for a more cohesive public realm identity in the City. It will also help to control the City's maintenance, operations and replacement costs.



Design Driven

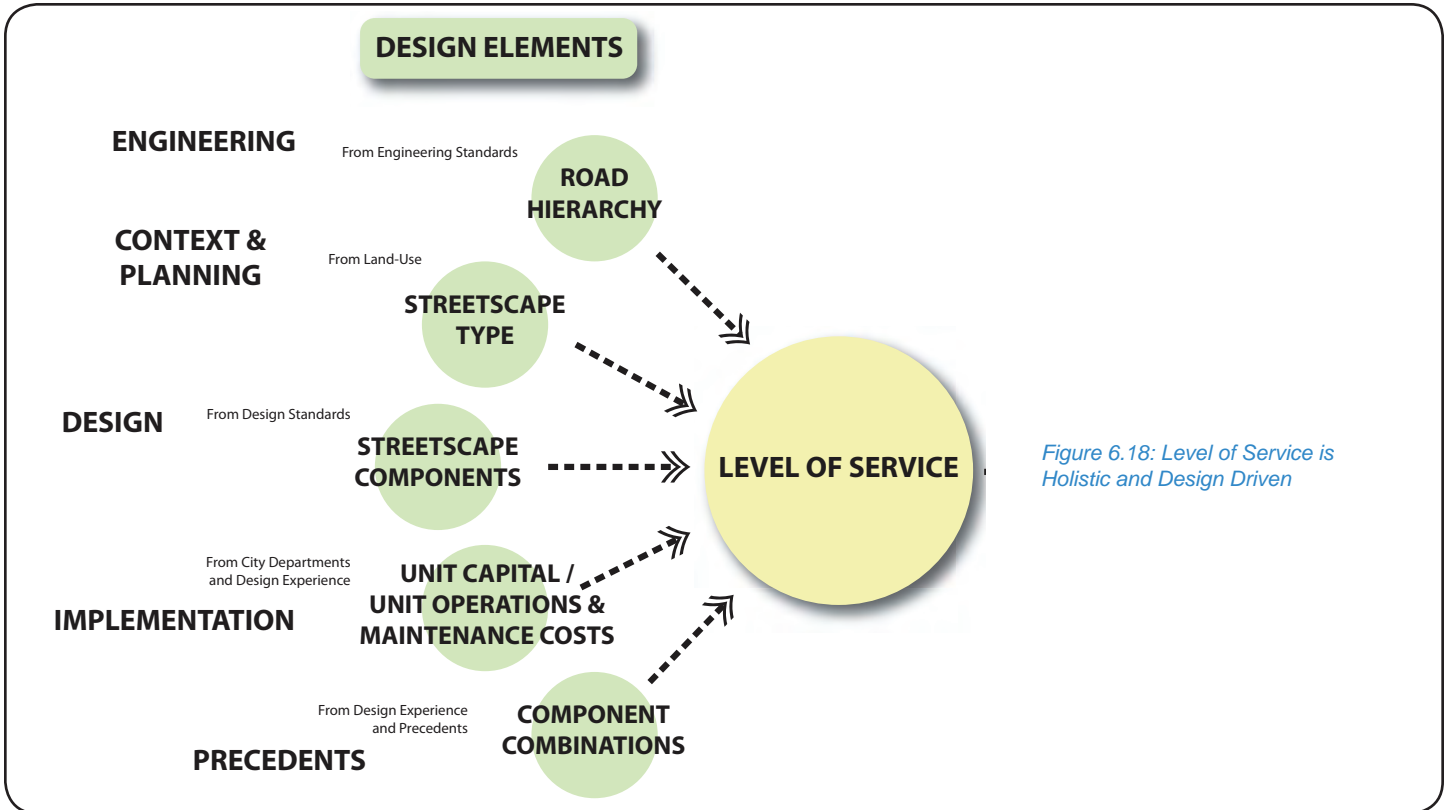

Figure 6.18: Level of Service is Holistic and Design Driven

The level of service concept consolidates considerations from engineering, urban planning and design, operations and maintenance, municipal finance and politicians. While design driven, this concept is a tool to address the balance between design, function and cost in a single language.

The importance of the concept is the ability to categorize a response to adjacent land use with design versatility while maintaining a coherent public realm identity. The level of service concept provides a simple way of understanding the design and financial differences between subsequently higher quality streetscapes. It creates a “typical prototype” to understanding streetscape construction and planning.

The manual identifies the historic (existing) streetscape level of service as a baseline. This “Basic” level of service is a design that responds to a suburban context. Three new streetscape levels of service have been defined to respond to urban conditions:

- Standard Urban
- Enhanced
- Premium

Each fundamental level of service represents a subsequent increase in design quality, versatility, pedestrian comfort / amenity and capital cost.

The following research, found in Appendix H / I / J, were used to develop the level of service concept and can be used as tools moving forward in the planning and design of streetscapes.:

- [Streetscape Component Selection Matrix](#)
- [Streetscape Component Breakdown Chart](#)
- [Operations and Maintenance Chart](#)

Description of Basic Level of Service

The existing Vaughan engineering standard for streets is used as the base reference streetscape - the “Basic” Level of Service. The existing streetscape standard, consisting of a 1.5m wide concrete sidewalk, street lights, sodded boulevards, and street trees, is a response to a low density context, not urban streets or Heritage Conservation Districts.

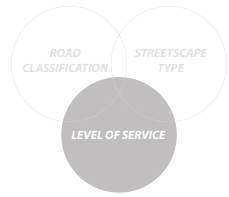

Level of Service Cross Sections

It is important to note that the capital and operations and maintenance costs of the Basic level of service reflect base standard suburban major collector streetscapes and not suburban residential streetscapes. This is important since suburban residential streetscapes have minimal municipal operations and maintenance activities.

Typical streets have been created to demonstrate **design quality** and cost differences among the **levels of service**

The proposed levels of service are as follows:

1. Standard Urban is the minimum level of service designed to meet the functional requirements of an urban streetscape. It includes a 2.0 m wide concrete sidewalk for two people to walk side by side, street trees and understorey planting, and provides the option for a concrete continuity strip and amenity zone instead of sod. The Standard Urban level of service has the lowest capital, maintenance and replacement costs and is currently recommended as the most common level of service in intensification areas. The design framework set out through the Streetscape Implementation Manual is flexible to allow for the design of a Standard Urban streetscape to be re-assessed in the future, as the City's population grows, to incorporate technological/ material advancements, additional components, and/or an increased standard sidewalk width, if necessary.
2. The Enhanced streetscape is a higher level of service with additional and/or higher quality component options added to the design components menu. An Enhanced streetscape design may include pedestrian lighting, decorative paving, structural soil cells, and/or street furnishings in addition to the Standard Urban components. The Enhanced level of service has higher

capital, maintenance and replacement costs than the Standard Urban level of service. It is anticipated that approximately 40% of streetscapes located within Intensification Areas will strategically qualify for an Enhanced Level of Service, based on a set of evaluation criteria outlined in the Streetscape Implementation Manual

3. A Premium streetscape is the highest level of service, allowing for the highest quality of materials, the most pedestrian amenity, and the most creative flexibility to design an iconic public destination of significant civic or community importance. As the most unlimited design category, Premium streets may have, for example, special furnishings, accent lighting, natural stone paving or other unique features in addition to the design component options within the Enhanced and Standard Urban levels of service. A Premium streetscape is designed to support significant economic generators, such as the Main Street of a Primary or Local Centre, or streets fronting buildings of cultural and artistic significance, such as museums, performing arts buildings and galleries. Premium streetscapes also may be applied when the block has significant civic importance, such as fronting major civic buildings or major public squares and parks. Premium streetscapes are an investment in the civic, cultural and social generators of the City with the highest per linear metre capital, maintenance and operation and replacement costs allocated to them. It is anticipated that approximately 3% of streetscapes located within Intensification Areas and Heritage Conservation Districts will qualify for Premium level of service.

Each cross-section is designed to represent the typical level of service character over a mid-block condition. Cost estimates (per linear meter costs) have been derived to characterize the potential financial commitment to each level of service streetscape. The per linear meter costs for each typical level of service cross-section are for typical character designs and do not represent specific master plan designs. In Enhanced and Premium levels of service there is greater design versatility with a high range of potential design components which leads to a greater range of potential cost. Therefore it should be noted that the typical level of service cross-section costs may vary in relation to actual master plan designs.

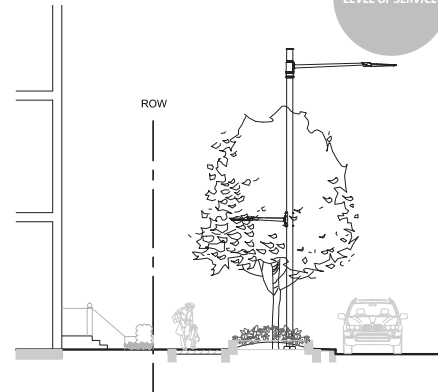
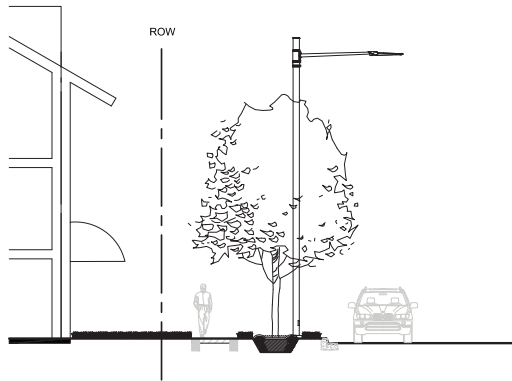
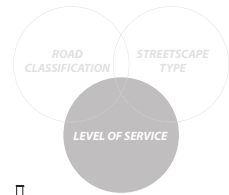

Basic Level of Service

Basic level of service is a representation of the existing suburban road in its most fundamental form. It provides the minimum functionality of a streetscape for a street with low pedestrian volume and activity. The streetscape has a narrow concrete sidewalk (1.5 m) and sodded boulevard with street trees. The basic level of service will not typically apply to urban intensification areas or commercial areas within Heritage Conservation Districts.

Typical characteristics:

- Low intensity pedestrian traffic
- Standard sidewalk width (1.5 m)
- Standard concrete
- Sod and street trees
- Standard street lighting

Typical Costs Single Sided

Capital Cost: \$515 / linear meter
 Operations and Maintenance: \$15 / linear meter / yr
 (2013 Canadian dollars)

Typical Boulevard Width: 5.5 - 6.0 m



Standard Urban Level of Service

Standard Urban level of service is a basic streetscape for an urban context. Standard Urban level of service provides predominantly hardscape options as a design response to higher pedestrian traffic from greater population density of urban areas. The Standard Urban streetscape replaces the Basic streetscape for those within a more urban settings.

Typical characteristics:

- Street related uses, urban intensity, and higher pedestrian traffic
- Larger pedestrian clearway width (2.0 m) to accommodate more pedestrian activity
- Standard concrete
- Street trees in urban pits

Typical Costs Single Sided

Capital Cost: \$975 / linear meter
 Operations and Maintenance: \$100 / linear meter / yr
 (2013 Canadian dollars)

Typical Boulevard Width: 5.5 - 6.0 m



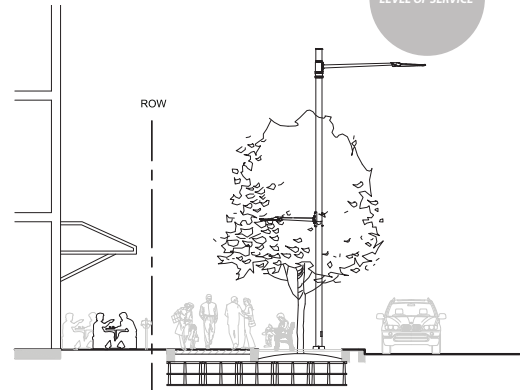
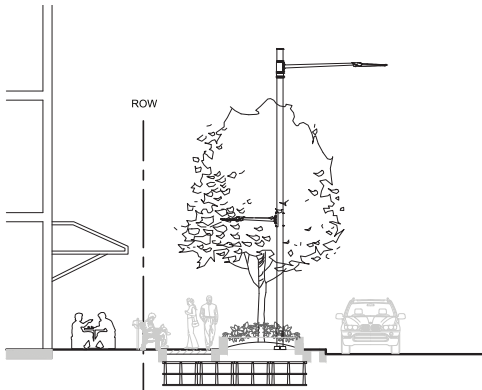
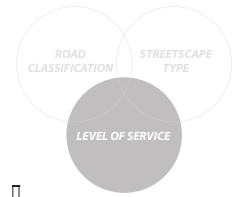

Enhanced Level of Service

The Enhanced level of service responds to areas with greater pedestrian traffic and a greater variety of activities within the streetscape associated with urban retail, commerce, transit, entertainment and civic uses. Enhanced level of service permits a wider range and quality of materials which also is associated with higher costs. Enhanced Streets offer a variety of pedestrian amenities such as street furniture, enhanced paving, ornamental planting, pedestrian and accent lighting, and low impact development measures.

Typical characteristics:

- Street related uses, urban intensity, and higher pedestrian traffic
- Materials reflect quality of place
- Greater use of unit paving and accent designs
- Larger clearway width for more pedestrian activity
- Street furniture, enhanced tree planting and pedestrian lighting to create a safer, more pedestrian-friendly environment
- LID and sustainability features

Typical Costs Single Sided

Capital Cost: \$1,855 / linear meter
 Operations and Maintenance: \$150 / linear meter / yr
 (2013 Canadian dollars)

Typical Boulevard Width: 5.5 - 6.0 m



Premium Level of Service

Premium level of service is the highest level of streetscape quality. For areas of high pedestrian visibility, cultural significance and special cases, the Premium level of service uses the highest quality materials, offers the most pedestrian amenity and the highest level of design. Premium level of service streets are memorable pedestrian experiences, often the main street of an Urban Intensification Area or Heritage Conservation District and can often become destinations and iconic streets.

Typical characteristics:

- High urban intensity, special streets
- High quality materials to attract and accommodate higher levels of investment and pedestrian traffic
- Large pedestrian zones with amenities (shrub and perennial planters, street furniture, etc.) to create a memorable experience
- Accent lighting to highlight interesting elements
- Tree infrastructure to help trees survive in an urban environment
- Special features and public art

Typical Costs Single Sided

Capital Cost: \$2,325 / linear meter
 Operations and Maintenance: \$170 / linear meter / yr
 (2013 Canadian dollars)

Typical Boulevard Width: 6.0 - 7.0 m



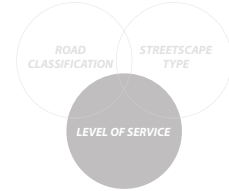

LEVEL OF SERVICE

Determining Level of Service

Figure 6.18: Master Plan Stream - Determining Level of Service

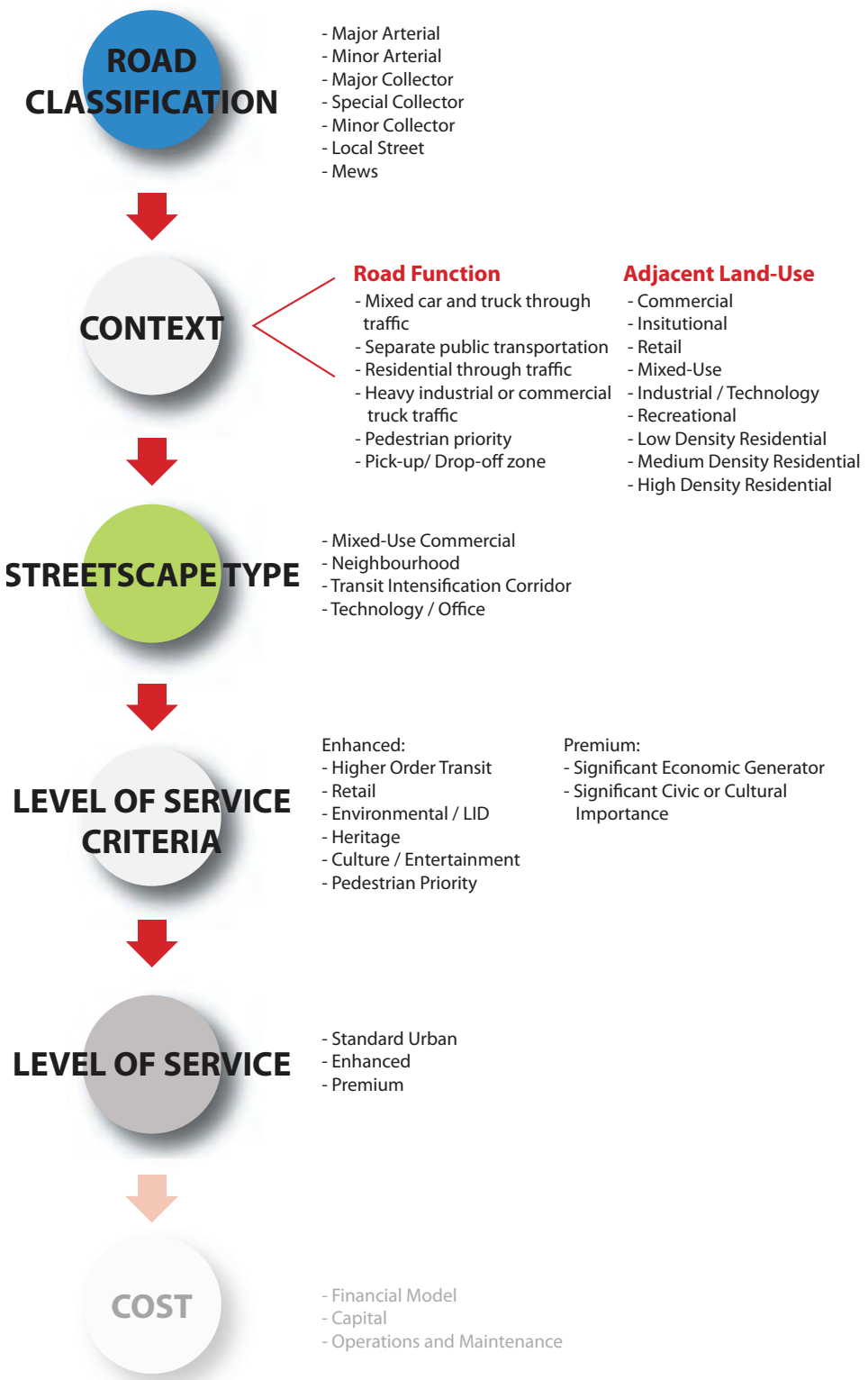

Master Plan Stream

The level of service for a streetscape is initially determined at the master planning stage and includes the use of the financial model, developed in conjunction with the Vaughan City-Wide Streetscape Implementation Manual.

A level of service is applied on a block by block basis, i.e. from intersection to intersection on each side of the street. In order to determine the level of service for each block, the road classification, context, streetscape type and criteria for levels of service are considered.

A consistent intersection design acts as a hinge point or transition between blocks that may have either the same or different streetscape levels of service.

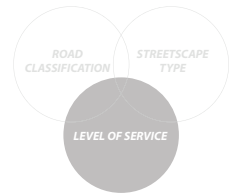

Road Classification

To determine the level of service of a streetscape the designer must first consider the roadway. The street classification of the roadway partly determines the function of the vehicular roadway but also the jurisdiction. This is an important input into the financial model and has implications for financial funding and commitments. Roads can be classified as:

- Major Arterial (Regional Jurisdiction)
- Minor Arterial (Municipal Jurisdiction)
- Major Collector (Municipal Jurisdiction)
- Special Collector (Municipal Jurisdiction)
- Minor Collector (Municipal Jurisdiction)
- Local Street (Municipal Jurisdiction)
- Mews (Municipal Jurisdiction)

Context

Context is governed by both the roadway function and adjacent land use. Both the roadway and adjacent land use functions have an impact on the pedestrian boulevard. The functions of the roadway and adjacent land use determine the design response of the streetscape and therefore determines the streetscape type. For example, roadways that are transportation truck corridors or vehicular corridors will have a high volume of vehicular traffic and impact pedestrians in the pedestrian boulevard. The streetscape design response would need to provide a buffer between the roadway and pedestrians. Alternatively, an adjacent land use of retail would require a seamless transition between the pedestrian clearway zone and the retail frontage to encourage retail activities.

Roadway function considerations include:

- Vehicular Corridor
- Transport Truck Corridor
- Public Transit Priority
- Pick-up / Drop-off Zone
- Flexible Street

Adjacent land-use considerations include:

- Commercial
- Institutional
- Retail
- Mixed-use
- Industrial / Technology
- Recreational
- Low Density Residential
- Medium Density Residential
- High Density Residential



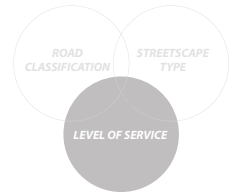

Streetscape Type

The streetscape type represents the design response to the context of the roadway function and adjacent land use. Section 3 describes each streetscape type and their associated context. The four streetscape types are:

- Mixed-Use Commercial
- Transit Intensification Corridor
- Technology / Office
- Neighbourhood

Level of Service Criteria

All streets in urban intensification areas start at a Standard Urban level of service. As the level of service increases, the design is eligible to use a greater variety of components to respond to specific design challenges and opportunities (see Appendix H, Streetscape Component Selection Matrix). For a streetscape to qualify for a higher level of service the streetscape must consider a number of criteria. A set of criteria to determine if a streetscape is an Enhanced level of service, while a separate set of criteria outlines when the streetscape is a Premium level of service. Streetscapes warranting an Enhanced level of service have the presence of the following criteria:

- Retail
- Culture / Entertainment
- Higher Order Transit
- Heritage
- Environmental
- Pedestrian Priority

Premium levels of service will have the presence of Enhanced criteria, but additionally are:

- Significant Economic Generators
- Of Significant Civic / Cultural Importance

The level of service criteria are explained in greater detail on the following pages.

Level of Service

The streetscape level of service is then finalized with the application of the upgrade criteria. Each level of service has an associated prototype cost which is found in the financial model.

Cost

Costs are determined by the inputs of each step into the financial model including phasing and funding considerations. Alternatively, multiplying the per linear meter cost of each level of service by its associated block length yields a simple cost estimate based upon design.



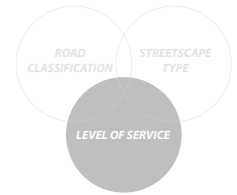

Enhanced Level of Service Criteria

Enhanced levels of service offer a wider design palette than Standard Urban levels of service to better address the appropriate design and functional needs of specific streetscapes. To upgrade a streetscape from an Standard Urban level of service to an Enhanced level of service, any **one** of the following criteria should be met.



Enhanced Level of Service Streetscape

Enhanced Level of Service Criteria

Retail

Retail designated streets typically have a higher volume of pedestrian traffic and a greater variety of activities. The combination of its economic function, visibility, and heavy pedestrian usage support investment in a higher level of service. Primary and secondary designated retail streets usually require higher levels of service, while tertiary retail streets may or may not.

- *Increased durability for higher volume pedestrian traffic*
- *Pedestrian priority*
- *Support at grade retail and restaurants*
- *District branding*
- *Economic development*

Culture / Entertainment

Streetscapes with cultural and entertainment facilities and functions may be iconic streets that define a city. Their visibility, heavy pedestrian usage, economic function, cultural importance and branding value support investment in a higher level of service. Special connections to cultural amenities via passageways or mews would also upgrade the level of service.

- *Increased durability for higher volume pedestrian traffic*
- *Economic development*
- *Cultural and arts importance*
- *Special pedestrian connections and trails to cultural amenities*
- *District branding*

Higher Order Transit

Streetscapes along higher order transit areas must support increased pedestrian traffic. Mobility hubs and regional connections are examples where an interaction between different modes of transportation along these streetscapes require a more robust design solution for increased pedestrian safety. Higher order transit, in the form of mobility or transit hubs, are nodes that have a wide affect that are not exclusive to any one streetscape. Therefore, the higher order transit criteria for mobility or transit hubs can generally apply to streets located within the primary zone of the hub (approximately 250 m radius, or two minute walk).

- *Increased durability for higher volume pedestrian traffic*
- *Pedestrian priority*
- *Transportation importance*

• **Cultural Importance Heritage**

Streetscapes with heritage importance, such as Heritage Conservation Districts, are special streets which require specific design requirements. To maintain its historical character, heritage streetscapes often need special materials or custom construction. Streetscapes within heritage conservation districts may have an upgraded level of service to accommodate the special design requirements.

- *Cultural importance*
- *District branding*
- *Economic development*

Environmental

Some streetscapes have an added environmental value over and above the green infrastructure / ecosystem services provided by a standard urban street. For example, streetscapes with low impact development measures for stormwater management, double rows of trees or structural soil cells.

- *Double rows of trees*
- *Special planting*
- *Low impact development measures*
- *Structural soil cells*

Pedestrian Priority or Pedestrian Area

Pedestrian Priority Zones could be designed as a mews or a flexible space street. Detailed consideration must be given to ensure the design is accessible to all road users. Design features may include the reduced use of demarcation and signage, flush / level surfaces, rolled curbs, elevated intersections, planting, pedestrian-scale lighting and furnishings.

A Pedestrian Area is dedicated to pedestrians, and only authorized vehicles are permitted in the area (such as for servicing or emergency access). Transit services may also be permitted where necessary. A street may be permanently a Pedestrian Area, such as a pedestrian-only mews, or created as a temporary Pedestrian Area through road closures for special events or seasons.

- *Increased durability for higher volume pedestrian traffic*
- *Economic development*
- *Cultural and arts importance*
- *District branding*

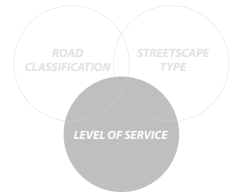

Premium Level of Service Criteria

Premium streetscapes are significant and memorable streets in a City. As the single most important street in a district, the Main Street or a high end retail street should be designed as a Premium Street. For a streetscape to be classified for a Premium level of service, it should be anticipated to become a significant economic generator or be of significant civic / cultural importance.



Premium Level of Service Streetscape

Premium Level of Service Criteria

Significant Economic Generator

Streetscapes that are significant economic generators are Premium level of service. The reason for this is the synergy and mutual benefit generated between Premium streetscapes and significant economic generating land uses. For example, Business Improvement Areas (BIAs) often recognize the importance and correlation of the quality of the public realm to their success, and accordingly invest in streetscapes. Premium level of service streetscapes are significant economic generators which benefit from the high level service and can be maintained by the land uses they serve. Significant economic generators are typically high end or primary retail.

The retail criteria for Enhanced level of service is similar to a significant economic generator, however the difference is found in the degree of significance. An Enhanced street may have primary retail, however it may not have the regional significance of, for example, Yorkville in Toronto or Soho in New York City. Premium level of service streetscapes with significant economic generators are intended to have regional significance and name recognition for their quality and experience.

Examples of land uses that are significant economic generators include, but are not limited to:

- *High end primary retail*
- *Intensive primary retail*

Significant Civic / Cultural Importance

Streetscapes with significant civic and cultural importance can directly and indirectly generate economic benefit for surrounding land uses. Major urban squares, art galleries, performing arts buildings, city halls and museums are places of civic pride and activity. Streetscapes which are associated with spaces with significant civic and cultural importance have a personal and emotional attachment for individuals. These are often streetscapes which are associated with spaces of major regional or civic events and major performances. These streetscapes therefore form an identity and brand and represent the district at a regional scale. These are spaces and streetscapes to be celebrated and therefore require a Premium level of service.

The criteria of significant civic / cultural importance is similar to the culture / entertainment criteria for an Enhanced level of service. The difference between the two criteria remains in the significance of the importance. For example, there is cultural importance for cultural facilities of all sizes. However, facilities such as Toronto's Art Gallery of Ontario or New York City's Guggenheim hold a larger regional significance.

Examples of land uses which create significant civic and cultural importance include, but are not limited to:

- *Major urban squares*
- *City hall*
- *Art galleries*
- *Performing arts building*
- *Major museums*

LEVEL OF SERVICE

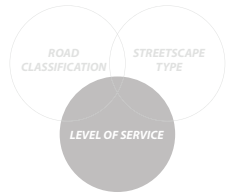

6

Level of Service Upgrade Criteria Chart

		LEVEL OF SERVICE		
		STANDARD URBAN	ENHANCED	PREMIUM
CRITERIA				
Retail				
	Increased durability for higher volume pedestrian traffic			
	Pedestrian priority			
	Support at grade retail		✓	
	District branding			
	Economic development			
Cultural / Entertainment				
	Increased durability for higher volume pedestrian traffic			
	Economic development			
	Cultural and arts importance		✓	
	Special pedestrian connections and trails to cultural amenities			
	District branding			
Higher Order Transit				
	Increased durability for higher volume pedestrian traffic			
	Pedestrian priority		✓	
	Transportation importance			
	Cultural importance			
Heritage				
	Cultural importance		✓	
	District branding			
	Economic development			
Environmental				
	Special planting		✓	
	Low impact development measures			
Pedestrian Priority or Pedestrian Area				
	Increased durability for higher volume pedestrian traffic			
	Economic development		✓	
	Cultural and arts importance			
	District branding			
Significant Economic Generator				
	High end primary retail			✓
	Intensive primary retail			
Significant Civic / Cultural Importance				
	Major urban squares			✓
	City hall and civic importance			
	Art galleries			
	Performing arts building			
	Major museums			

Figure 6.19: Level of Service Upgrade Criteria Chart

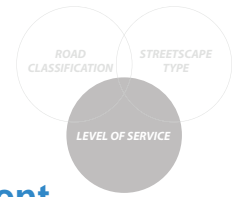

Streetscape Component Selection Matrix

Each level of service has an associated menu of streetscape components. The Streetscape Component Selection Matrix (see Appendix H) outlines which items are eligible in each level of service based upon the Streetscape Component Breakdown Chart (see Appendix I). The chart shows an increasing number of associated streetscape components from Standard Urban to Premium levels of service. The intent is that Premium streetscapes offer the greatest design versatility and pedestrian amenity by offering the widest selection of components to use in a design. Standard Urban streetscapes offer only the minimum standard and include the least variety of components. Therefore, higher levels of services may have access to lower level of service components while lower levels of service may not use higher level of service components.



Low Selection of Streetscape Materials

Streetscape Component Breakdown Chart

The Streetscape Component Breakdown Chart (see Appendix I) represents the deconstruction of the streetscape into its base components and sorted into the relevant zones the components would be typically found in. Different combinations of the components can be used to construct streetscapes to address different design contexts. Each level of service typical cross-section was constructed using the breakdown of the streetscape components ensuring that the costs associated with each level of service is relevant.

Each component is assigned a unit measurement, typical capital unit cost, an inherent level of service, and a typical life expectancy. The unit measurement and capital unit cost have been derived from current construction standards and will change over time. It is recommended that a review and update of typical construction costs be done every five years.

The level of service for each component is influenced by capital cost, operation and maintenance cost, quality and functional factors; it helps in establishing which components are eligible in each level of service in the Streetscape Component Selection Matrix.



Greater Selection of Streetscape Materials



Versatile Selection of Streetscape Materials

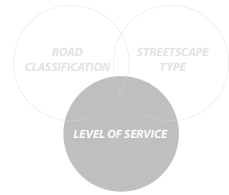

Operations and Maintenance

Beyond initial construction and capital costs, streetscapes also have annual operations and maintenance costs. Different streetscape components may have different operations and maintenance activities. Given that these activities and costs are recurring cost commitments it becomes important for municipalities to understand the future financial implications of such activities. Therefore, the level of service concept includes operations and maintenance.

Each streetscape zone is divided into maintenance elements where components with similar maintenance activities are combined together. Maintenance activities have been assigned cost assumptions approved by Vaughan and associated responsible departments. The costs have been applied across a streetscape to determine the potential future financial commitments for operations and maintenance (see Appendix J for Operations and Maintenance Chart).



Street Maintenance New York, United States

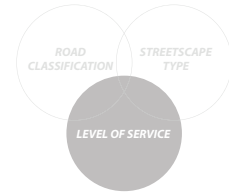

Using Level of Service for Design

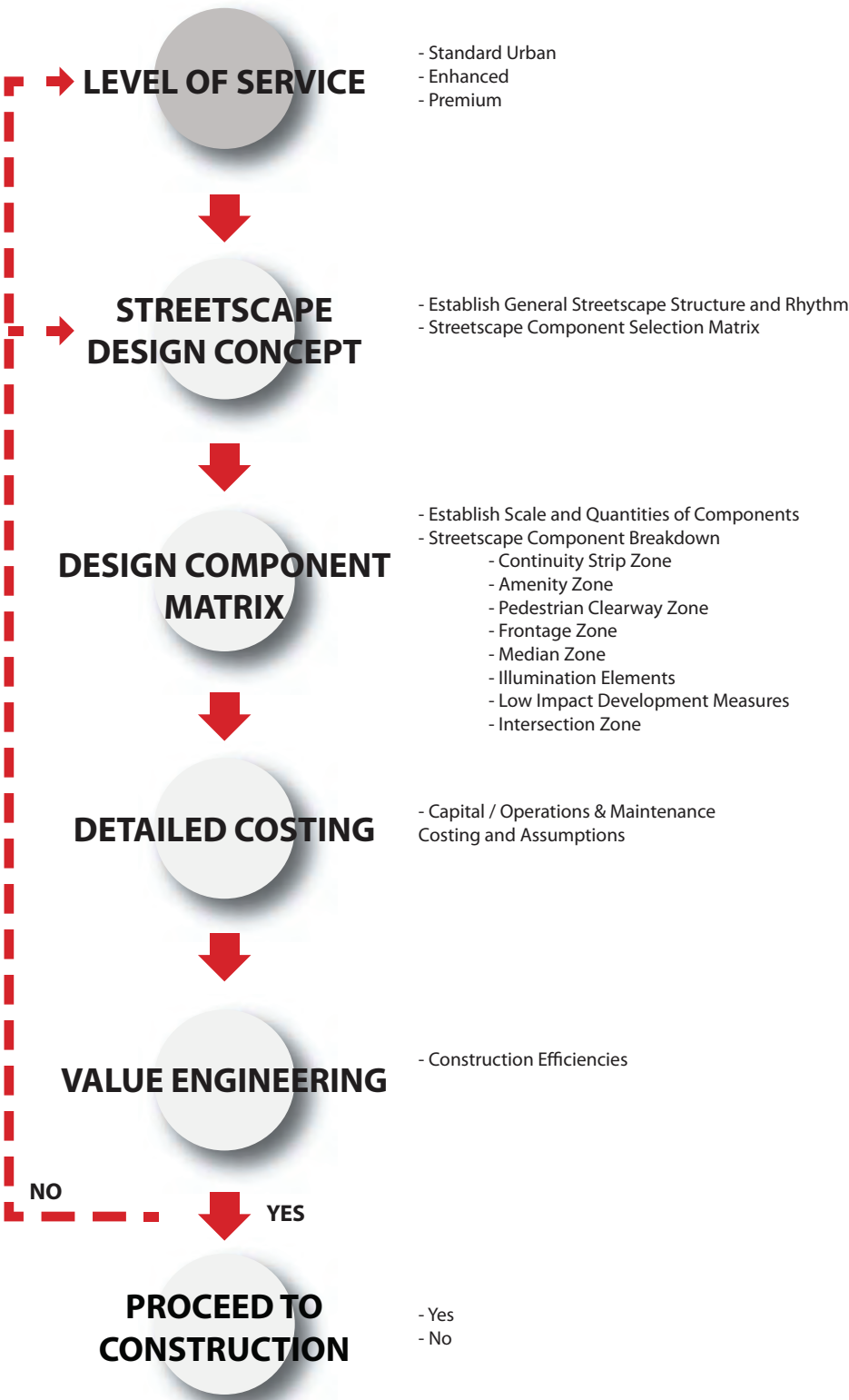

Detailed Design and Implementation Stream

The Detailed Design and Implementation Stream yields the level of service for each block along a streetscape, as well as a prototype design and estimated cost. The purpose of the Detailed Design and Implementation Stream is to take the determined levels of service and develop a detailed design.

Using the associated streetscape components allowed from the Streetscape Selection Matrix (see Appendix H) and the guidelines from the design components section, a more detailed design can be crafted.

A Streetscape Component Breakdown (see Appendix I) can then be used for a detailed costing of the design.

Figure 6.20: Detailed Design and Implementation Stream

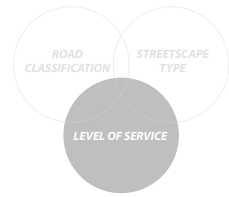

Level of Service

Determination of the level of service is typically done in the City Process, described in Section 4.

Streetscape Design Concept

Once the level of service for each block and side of the street is determined, the designer can use the Streetscape Component Selection Matrix (see Appendix H) to determine which components are available per the level of service of the streetscape they are designing. The Streetscape Component Selection Matrix contains the components categorized into the streetscape structure and determines which components are permitted. At this stage rhythm of trees and general structure and sizes of zones are determined to create a streetscape framework. The design framework is based upon the context criteria found in the City Process to respond to the roadway and adjacent land use functions.

Design Component Matrix

During the Design Component Matrix stage, sizes, scale and quantities of the streetscape components are established. These are placed in the streetscape design and used for the detailed costing. In circumstances where a project does not have a master plan to guide the design, Enhanced and Premium components (see Design Component Section) have been selected to ensure that streetscapes in Vaughan meet a minimum standard of quality and character.

Detailed Costing

At this point, designers have a detailed design of a streetscape and use the Streetscape Component Breakdown Chart (see Appendix I) to determine cost. The chart includes typical costs of potential streetscape components and their locations in the streetscape structure. The use of the Streetscape Breakdown Chart allows for all projects designed in the level of service concept to be compared on a similar level with the coinciding methodology. An Operations and Maintenance Assumptions Chart (see Appendix J) allows for the potential operations and maintenance costs to also be determined for a better understanding of the future financial impact to the City.

Value Engineering

The value engineering stage is an important part of the process to ensure that the design is as efficient as possible. Potential construction efficiencies should be explored and the cost of the project should be compared to the budget.

Proceed to Construction

After the project is value engineered, it is a Council decision as to whether to proceed with construction. If the project is approved, construction may proceed. However, if it is not approved due to cost or design, the project may return to the level of service phase to re-evaluate the level of service chosen and rework the design.



ONE ROSE
LOUNGE

STEWART ROSE
Lounge

JAZZ
at Lincoln Center

QUINO

shop
at Lincoln Center

NO STOPPING ANYTIME

←

←

←

←

←

←

←

←

←

←

←

←

←

←

←

←

←

←

←

←

←

←

←

←

←

←

←

←

←

←

←

←

←

←

←

←

←

←

←

←

←

←

←

←

←

←

←

←

←

←

←

←

←

Design Components

Strategy V

Design Components

Streetscape character is largely defined by the elements located in the public right-of-way, as well as the architectural design of building facades and landscaping treatment in the private realm setback. The combination of elements in a streetscape design also determines the functionality of the street infrastructure to respond to the adjacent land use and roadway. A simple way to think of the streetscape components is as a “kit-of-parts”. The components are mixed and matched to meet the needs of the streetscape. The general components of a streetscape can be broken down into the following categories:

- Paving
- Illumination Elements
- Planting
- Site Furnishings
- Medians
- Intersections
- Public / Private Frontage
- Utilities
- Innovation

General guidelines have been developed to guide the selection of materials and amenities. For design versatility, each component is explained in relation to design intent with graphic diagrams for each level of service, including information such as:

- Streetscape zones affected
- Potential materials
- Potential configuration in relation to other elements
- Typical ranges of component measurements

Innovation components are addressed differently than other typical streetscape components and may be applied on a permanent or pilot project basis. These include low impact development measures, the integration of new technologies, and public art installations, which are site and context specific.

In Heritage Conservation Districts component choices and design will need to comply with the specific Heritage Conservation District guidelines for that district.





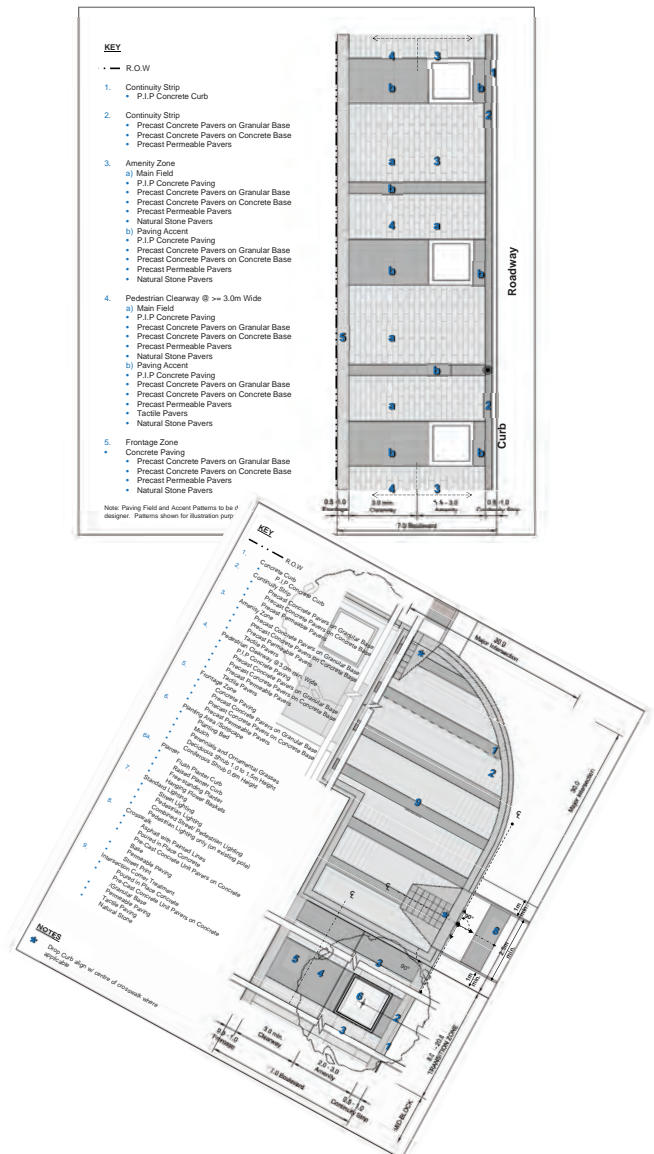









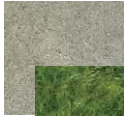

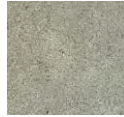



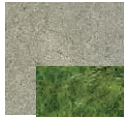









Design Components Matrix

The Design Components Matrix graphically shows the intended components available in each level of service as a potential palette of materials. In addition to the comparison of components between levels of service, several standard components have been selected for Enhanced and Premium levels of service in projects where there is no streetscape plan to guide the design. Approved streetscape plan designs may override the default.



Design Components Matrix

(for Urban Intensification Areas)

	Continuity Strip	Pedestrian Clearway	Frontage Zone	Seating	Bicycle Parking	Waste Receptacles	Pedestrian Lighting
Basic							
Standard Urban			 				
Enhanced	 	 	  				
Premium	  	  	  				

Accent Lighting

Street Tree Planting

Ornamental Planting

Custom Tree Grates/ Guards

Planters / Planting Islands

Street Media

Custom Branding / Wayfinding

L.I.D. Measures

Structural Soil Cells

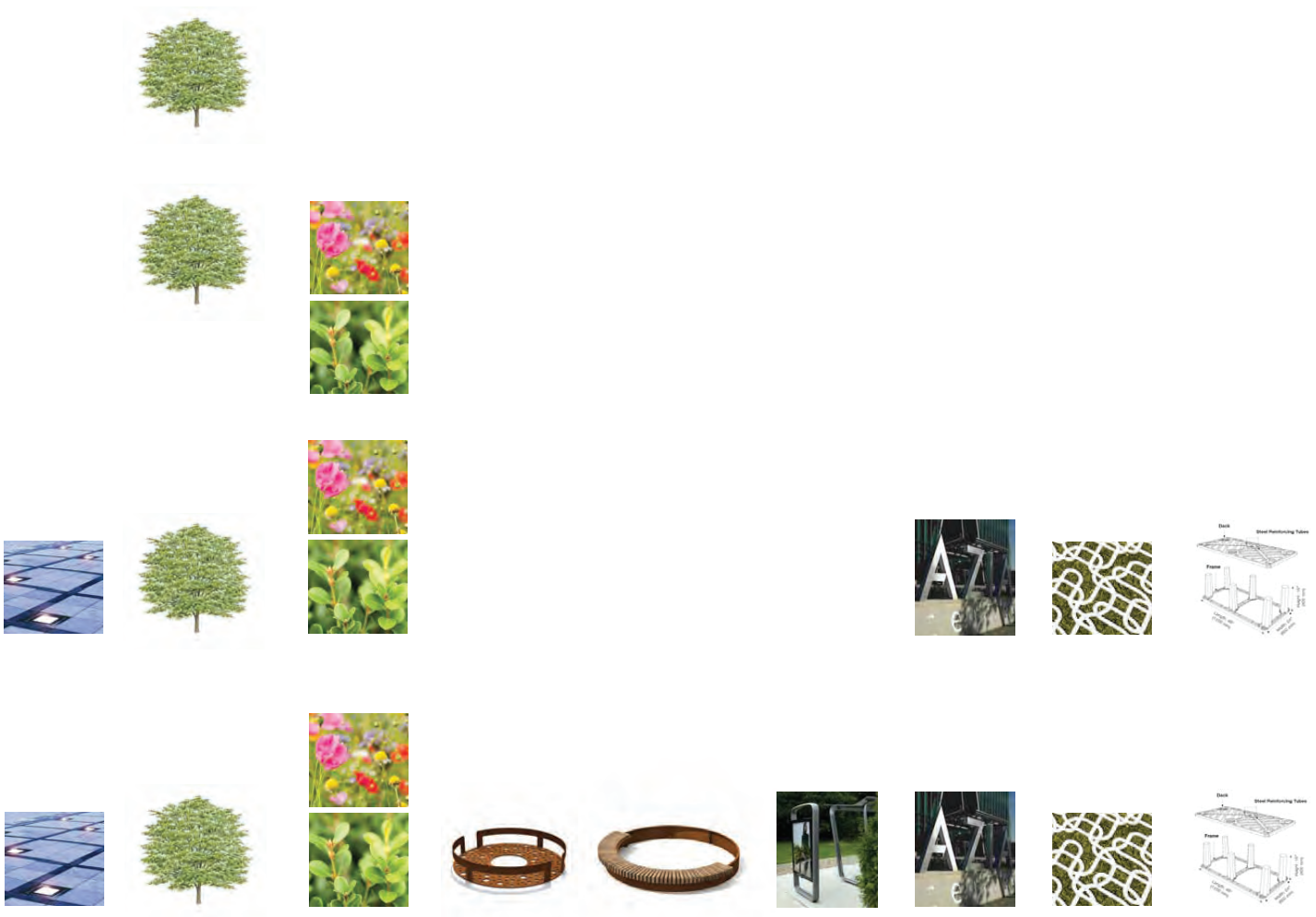

* Note: Premium streetscapes may include special or custom elements not shown in the matrix.

Design Components

For Enhanced and Premium Streets without Streetscape Plan Designs

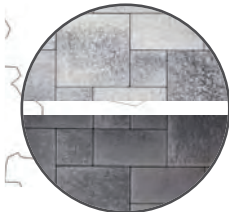
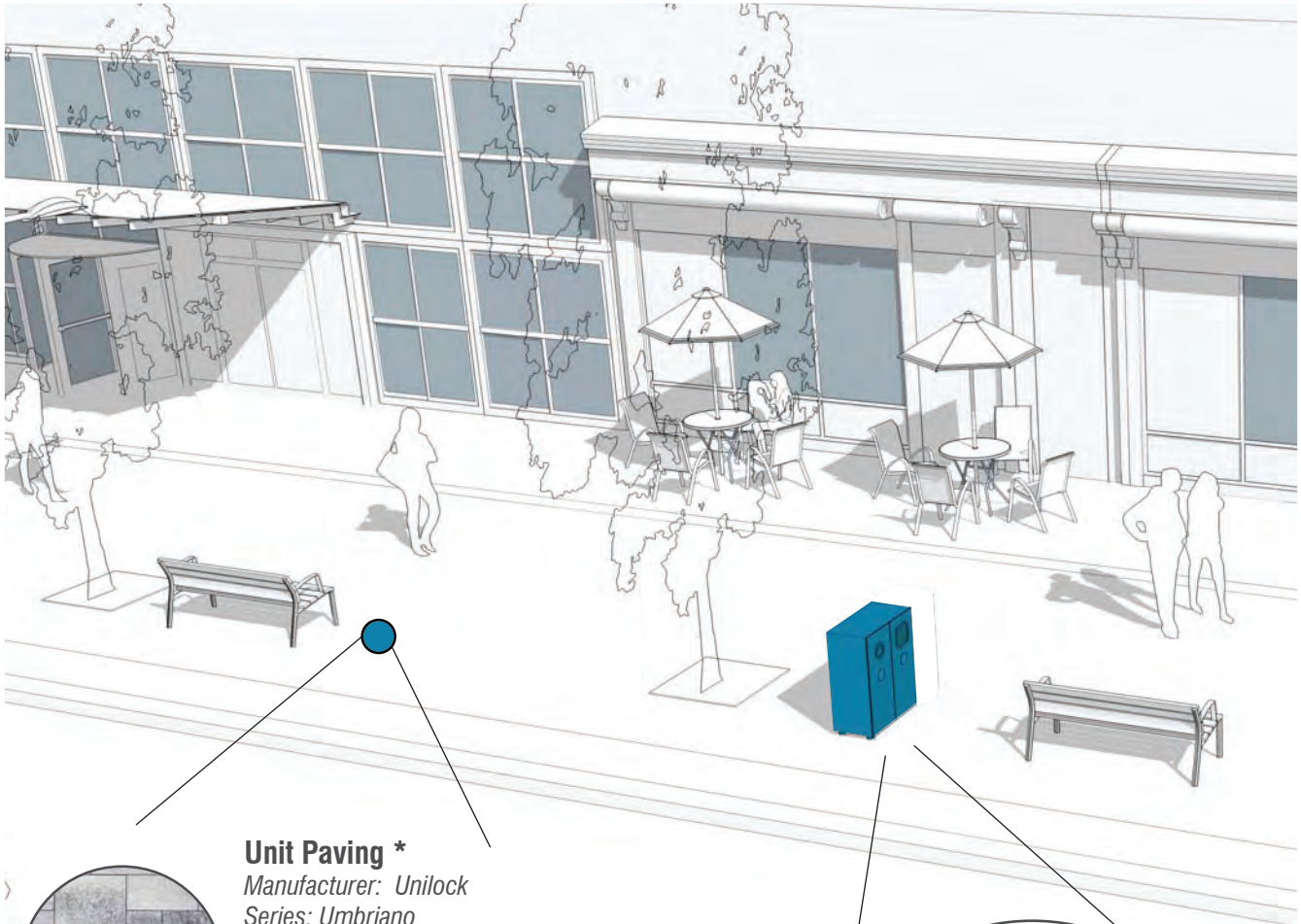

Unit Paving *
 Manufacturer: Unilock
 Series: Umbriano
 Colour: Winter Marvel (Field)
 Midnight Sky (Accent)
 (or other complementary colour)
 Feature: Non-bevelled top edge
 Base: Concrete

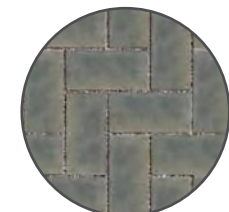

Permeable Paving *
 Manufacturer: Unilock
 Series: Eco-Priora
 Colour: Santa Fe
 (or other complementary colour)

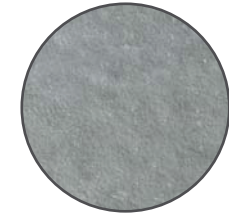

Natural Stone *
 Manufacturer: Unilock
 Series: Natural Stone
 Colour: Hearthstone
 (or other complementary colour)
 Base: Concrete



Waste Receptacles *
 Manufacturer: Landscape Forms
 Style: Select Letter Receptacle
 (double unit, solid body, perforated doors)
 Material: Powdercoated Metal
 Colour: Silver (body, door),
 Black (trim ring, signage plate)

Pattern: Large Format Plank Style

* Or Approved Alternative

* Or Approved Alternative

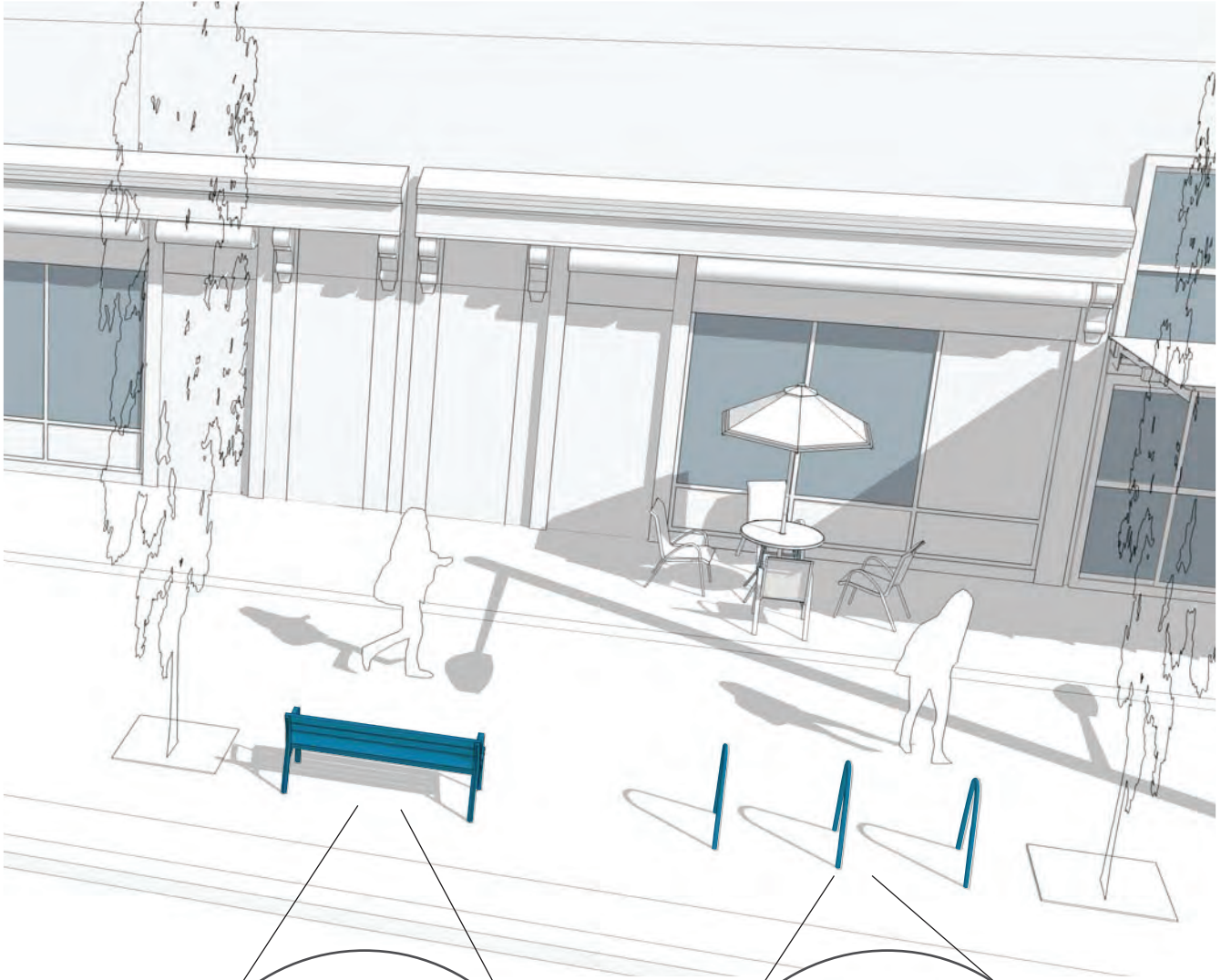

Streetscape Bench *

Manufacturer: Landscape Forms

Style: Neoliviano

Material: Metal / Wood

Colour: Aluminum Finish /

Jarah Wood

** Or Approved Alternative*

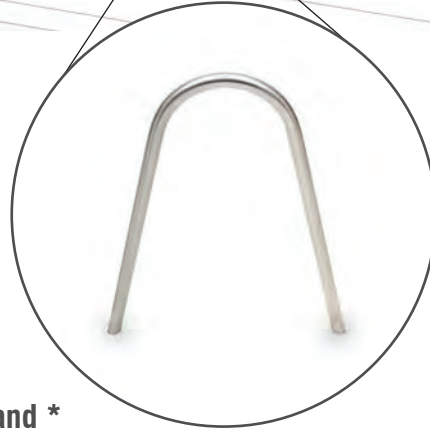

Bicycle Stand *

Manufacturer: Landscape Forms

Style: Bola

Material: Embedded Powder Coat

Colour: Stainless Steel

** Or Approved Alternative*

Typical Paving Pattern

For Enhanced and Premium Streets without Streetscape Plan Designs

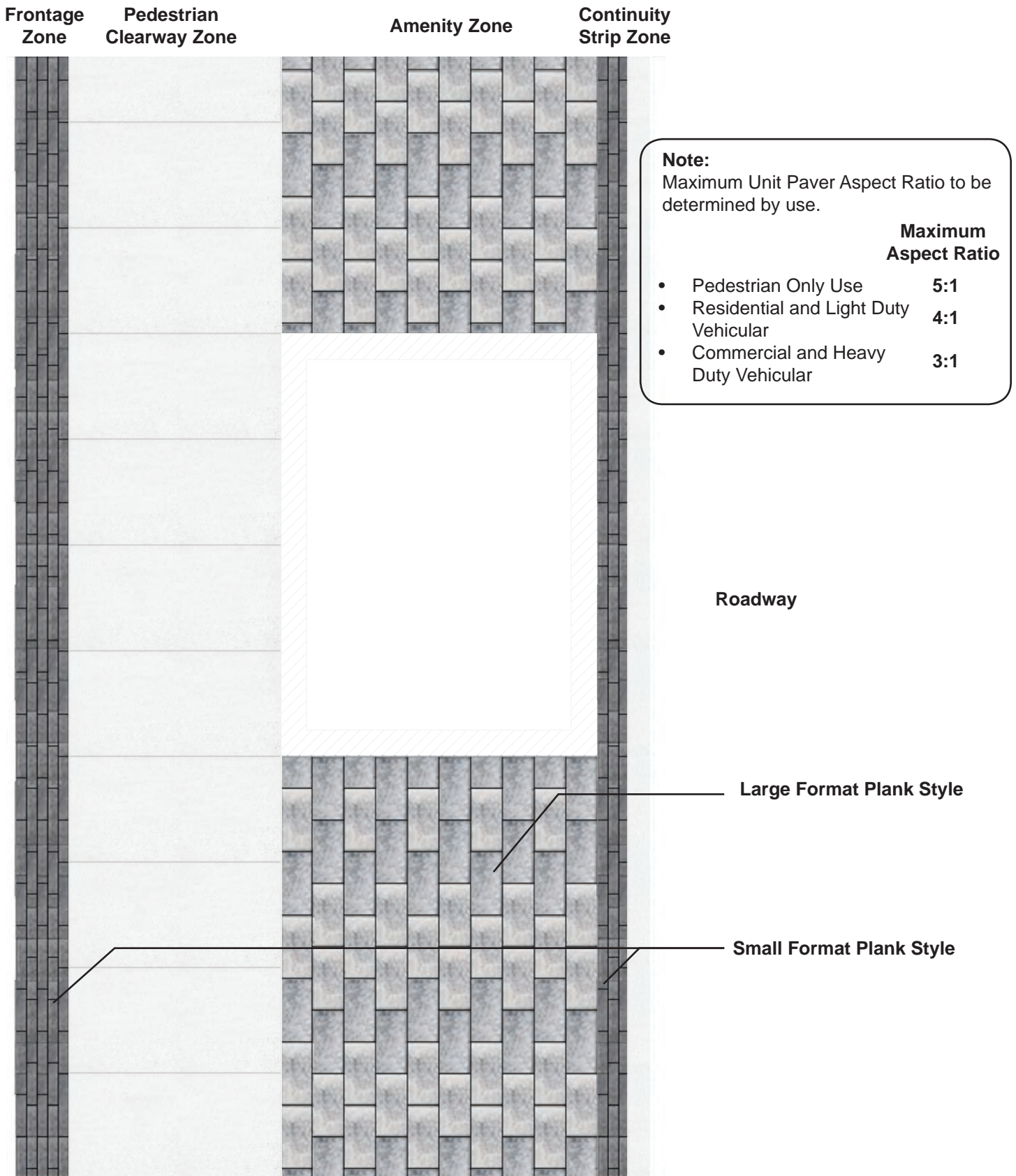

Figure 6.21: Typical Paving Pattern



Paving

Paving provides a flat surface, that can be easily navigated by pedestrians and designed to define areas and zones. The most common location for paving is in the pedestrian clearway zone (i.e., the sidewalk). However, in an urban setting, paving is also commonly found in the continuity strip, amenity zone, frontage zone and median. Paving is often divided into ‘field paving’ and ‘accent paving’, where field paving represents the most predominant material and colour and accent paving provides additional design and definition. Paving designs are a simple and effective way to define the zones in the streetscape.

Typically paving materials include:

- Poured-in-place concrete
- Precast unit pavers on concrete base
- Precast unit pavers on granular base
- Permeable paving
- Natural stone
- Tactile paving

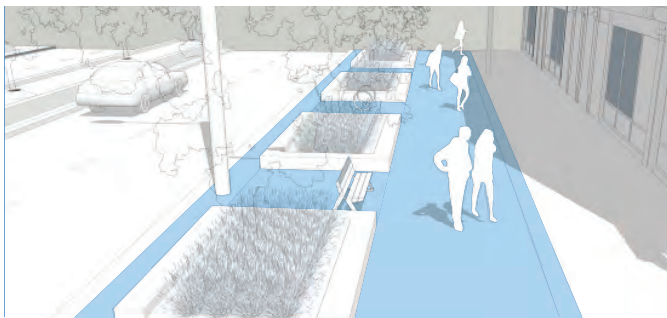

Planting

Planting represents the main visual amenity component found in the streetscape. Planting is generally used to create a visually appealing and comfortable pedestrian environment and acts as a buffer between pedestrians, cyclists and vehicular traffic. Planting plays a large part in forming the character of a streetscape. Street trees are one of the most utilized streetscape planting elements and provide a number of ecosystem service functions, providing shade, shelter, and oxygen. In an urban context, planting is mostly found in the amenity zone; however, in a low density context it can be found in all of the other zones, with the exception of the pedestrian clearway. Sod or grass often replaces paving as a ground element in low pedestrian volume areas. Typical planting components include:

- Street trees
- Sod
- Shrubs
- Perennials and ornamental grasses
- Seasonal planting
- Tree grates
- Planters



Illumination Elements

The most common and basic illumination elements are street lights. In general, lighting is a safety feature providing illumination for pedestrians, cycling and vehicular movement when it is dark. Street lights are primarily concerned with roadway illumination. Pedestrian lighting is used in higher pedestrian traffic areas to increase light levels for safety and for wayfinding. Pedestrian lights may be installed on pedestrian scaled poles or in combination with street light poles. Accent or specialty lighting can add additional safety to the streetscape and contribute to the character and experience of the street. Street lighting is generally found in the continuity strip or amenity zone, while pedestrian lights can be found in the amenity zone or frontage zone. At intersections, lighting and traffic signal poles should be coordinated to reduce obstructions and minimize clutter.

Illumination elements can include:

- Street lighting
- Pedestrian lighting
- Bollard lighting
- Paving lighting
- Accent lighting
- Seatwall lighting
- Tree up-lighting
- Wall wash lighting

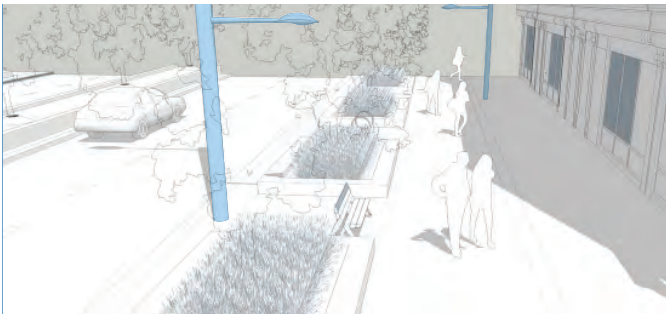

Site Furnishings

Site furnishings are generally functional streetscape amenities as opposed to aesthetic amenities. Benches provide places for pedestrians to sit and rest, while waste receptacles provide places for refuse to keep the streetscape clean. Bicycle stands provide parking for active transportation, similar to lay-by parking for vehicles. Site furnishings, mostly located in the amenity zone and frontage zone, vary depending on the level of pedestrian activity in the streetscape.

Typical site furnishings include:

- Bench
- Waste receptacle
- Bicycle stand
- Banners
- Wayfinding signage
- Bollard

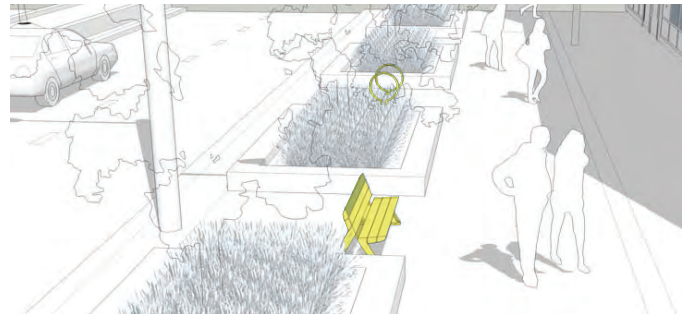

Innovation

The purpose of innovation components is to allow for non-typical state-of-the-art elements to be included in a streetscape design to continually experiment, lead and drive innovation. These include unique installations and infrastructure which have not been implemented before in Vaughan. Innovation components are often part of pilot projects to test feasibility and impact on the streetscape. The most common innovation components include low impact development measures such as storm water management rain gardens, bioswales and bio-retention ponds.

Potential innovation components include:

- Low impact development measures
- Public art
- Digital media and communication installations
- Flexible street design
- Planting strategies
- Temporary landscape installations

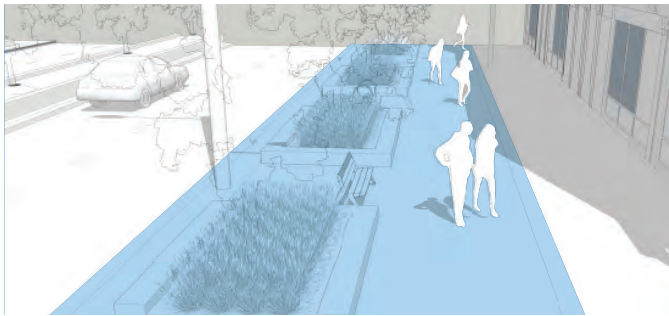

Paving

Paving supports pedestrian traffic, cycling and accessibility; it is always located in the pedestrian clearway zone. In urban environments, paving is also commonly located in the frontage zone, amenity zone and continuity strip zone.

Paving provides a definition of space, visual aesthetic and represents the character of the area. For example, definition of space for different modes of transportation can be achieved through the use of field and accent paving. Alternatively, using a single field of paving across a roadway and pedestrian boulevard creates the perception of a single space from building face to building face.

Function

- Supports pedestrian traffic
- Supports cycle traffic
- Supports accessibility
- Definition of space
- Visual aesthetic
- Character, identity and branding of an area

Unit Paving

- Unit paving may be constructed on a concrete or permeable concrete base (for durability and to avoid differential settlement) or with a granular base to allow for infiltration depending upon site context.

Pedestrian Clearway

- The pedestrian clearway zone should be paved and a minimum of 2 m wide Standard Urban and Enhanced levels of service.
- Premium levels of service should have a paved pedestrian clearway with a minimum of width of 3 m to accommodate increased pedestrian traffic flows.
- The pedestrian clearway paving should be free of obstacles.

Raised Cycle Track / Multi-Use Pathways

- Typical paving is asphalt.
- Where raised cycle tracks and multi-use pathways are located along Enhanced or Premium streetscapes, cycling facilities may be paved using concrete or coloured concrete complimentary to adjacent pedestrian clearway unit paving.
- Where applicable, multi-use pathways shall be differentiated from the pedestrian clearway with different colour paving.
- Cycling facilities must meet Ontario Traffic Manual Book 18: Cycling Facilities guidance.

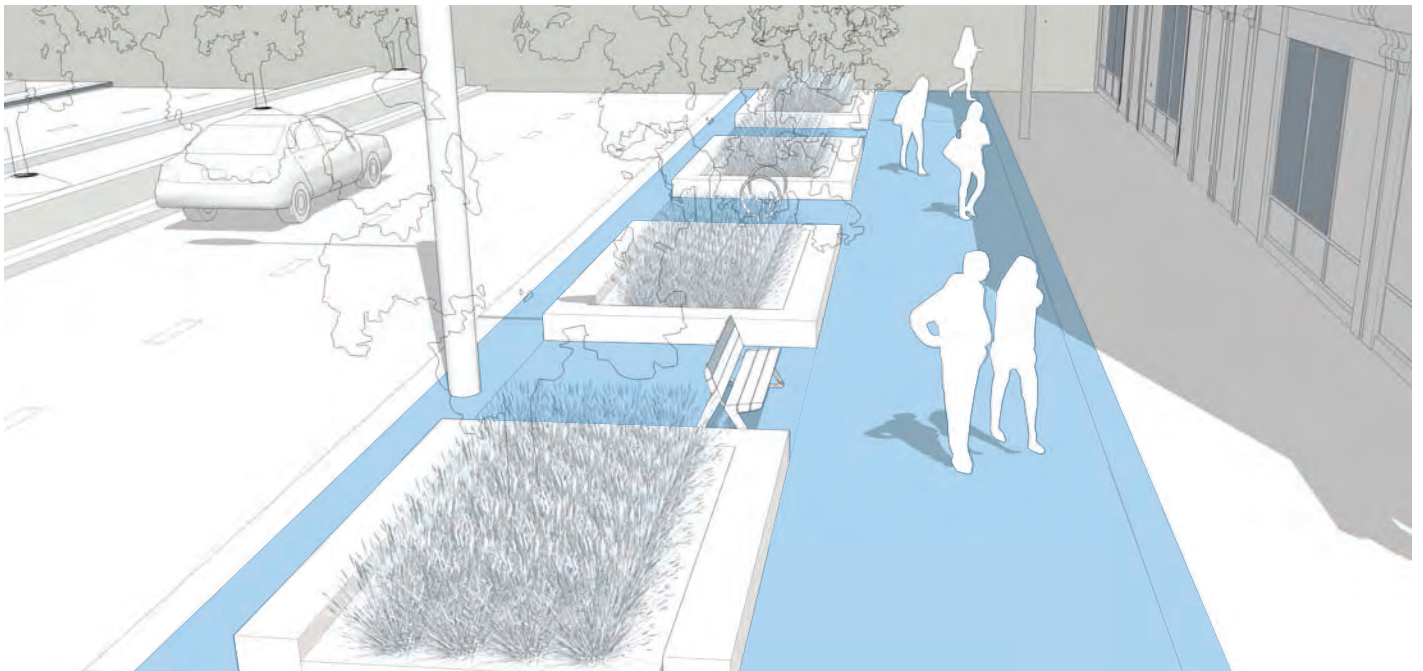
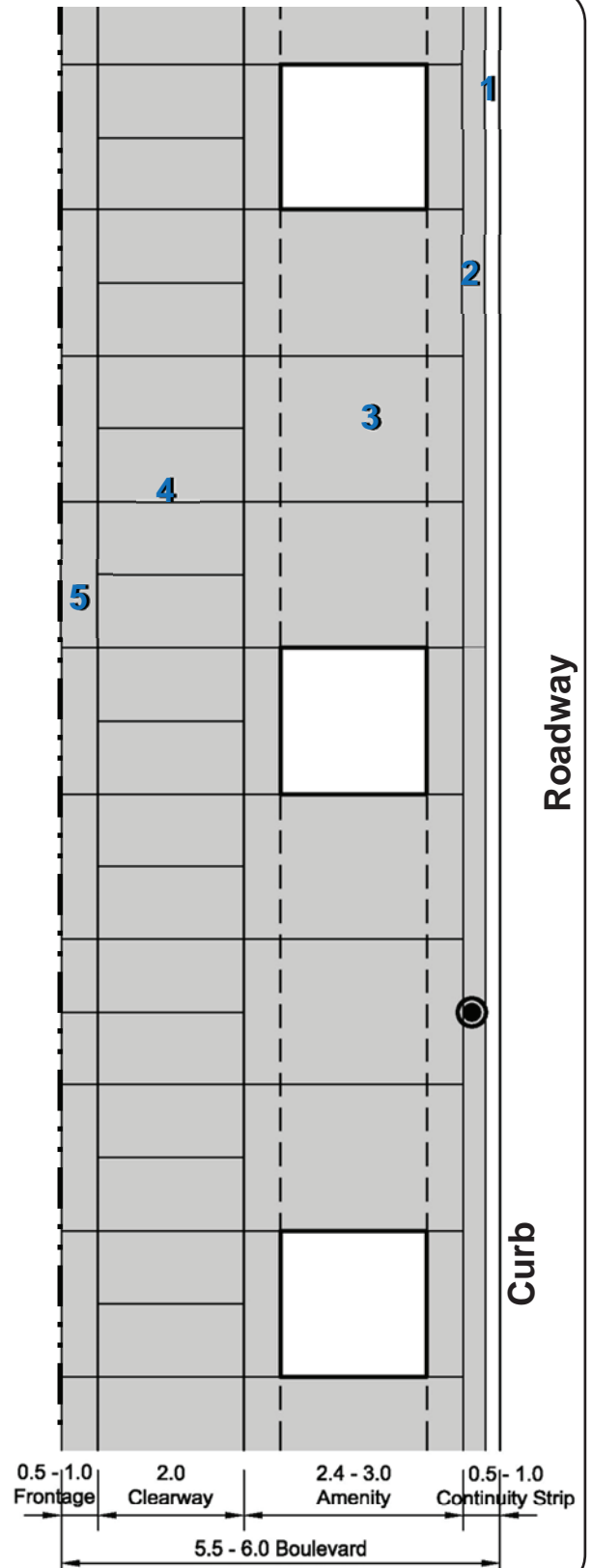

Figure 6.22: Paving

Standard Urban

KEY

- — R.O.W
- 1. Concrete Curb
 - P.I.P Concrete Curb
- 2. Continuity Strip
 - P.I.P Concrete
- 3. Amenity Zone
 - P.I.P Concrete Paving
- 4. Pedestrian Clearway 2.0m
 - P.I.P Concrete Paving
- 5. Frontage Zone
 - P.I.P Concrete Paving



Note: Paving Field and Accent Patterns to be determined by designer. Patterns shown for illustration purposes only.

Enhanced

KEY

- — R.O.W
- 1. Continuity Strip
 - P.I.P Concrete Curb
- 2. Continuity Strip
 - Precast Concrete Pavers on Granular Base
 - Precast Concrete Pavers on Concrete Base
 - Precast Permeable Pavers
- 3. Amenity Zone
 - Precast Concrete Pavers on Granular Base
 - Precast Concrete Pavers on Concrete Base
 - Precast Permeable Pavers
 - Tactile Pavers
- 4. Pedestrian Clearway 2.0m
 - P.I.P Concrete Paving
 - Precast Concrete Pavers on Granular Base
 - Precast Concrete Pavers on Concrete Base
 - Precast Permeable Pavers
 - Tactile Pavers
- 5. Frontage Zone
 - Concrete Paving
 - Precast Concrete Pavers on Granular Base
 - Precast Concrete Pavers on Concrete Base
 - Precast Permeable Pavers

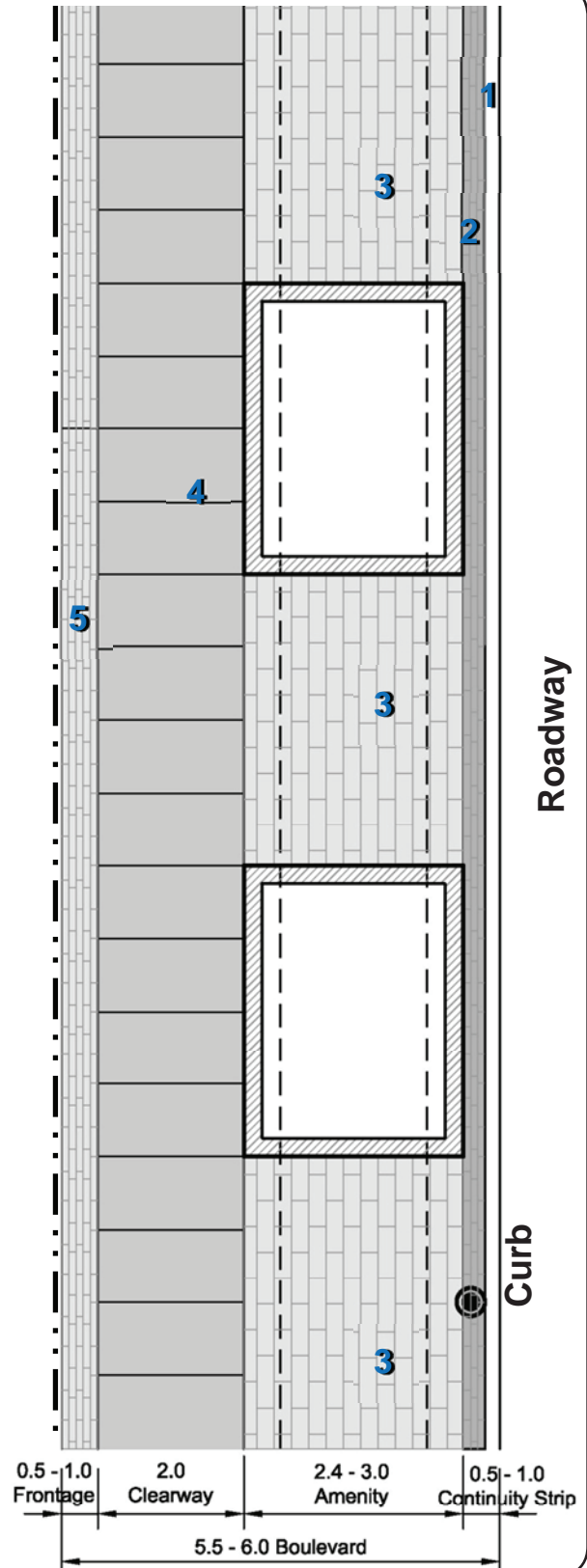

Note: Paving Field and Accent Patterns to be determined by designer. Patterns shown for illustration purposes only.

Premium

KEY

— R.O.W

1. Continuity Strip
 - P.I.P Concrete Curb
2. Continuity Strip
 - Precast Concrete Pavers on Granular Base
 - Precast Concrete Pavers on Concrete Base
 - Precast Permeable Pavers
3. Amenity Zone
 - a) Main Field
 - P.I.P Concrete Paving
 - Precast Concrete Pavers on Granular Base
 - Precast Concrete Pavers on Concrete Base
 - Precast Permeable Pavers
 - Natural Stone Pavers
 - b) Paving Accent
 - P.I.P Concrete Paving
 - Precast Concrete Pavers on Granular Base
 - Precast Concrete Pavers on Concrete Base
 - Precast Permeable Pavers
 - Natural Stone Pavers
4. Pedestrian Clearway @ $\geq 3.0\text{m}$ Wide
 - a) Main Field
 - P.I.P Concrete Paving
 - Precast Concrete Pavers on Granular Base
 - Precast Concrete Pavers on Concrete Base
 - Precast Permeable Pavers
 - Natural Stone Pavers
 - b) Paving Accent
 - P.I.P Concrete Paving
 - Precast Concrete Pavers on Granular Base
 - Precast Concrete Pavers on Concrete Base
 - Precast Permeable Pavers
 - Tactile Pavers
 - Natural Stone Pavers
5. Frontage Zone
 - Concrete Paving
 - Precast Concrete Pavers on Granular Base
 - Precast Concrete Pavers on Concrete Base
 - Precast Permeable Pavers
 - Natural Stone Pavers

Note: Paving Field and Accent Patterns to be determined by designer. Patterns shown for illustration purposes only.

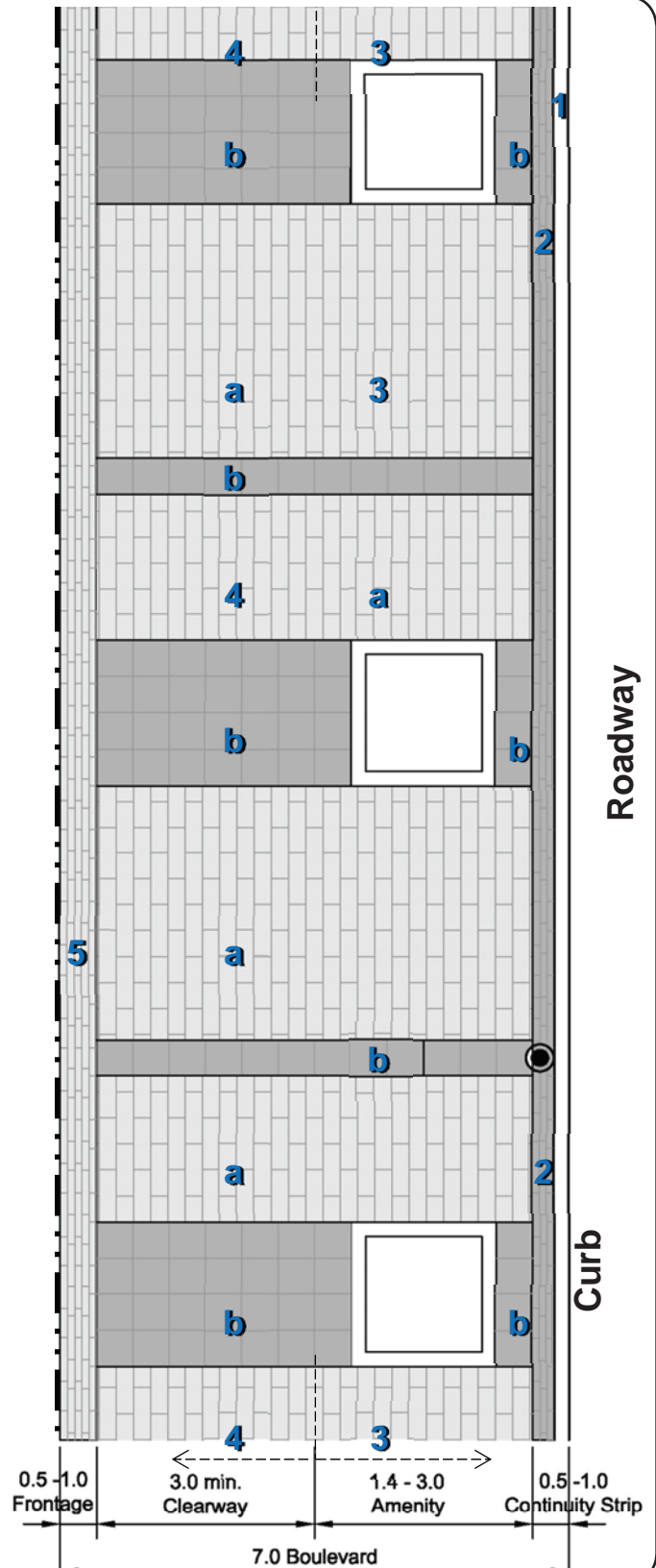

Illumination Elements

Illumination elements include street lighting, pedestrian lighting and accent lighting. Street lighting provides basic lighting requirements for vehicles, while pedestrian lighting adds additional comfort and safety for streetscapes with pedestrian traffic during the night. Accent lighting is beneficial for streetscapes which have heavy pedestrian activity during the night including restaurant, retail and entertainment districts. Lighting influences the overall experience of spaces and contributes to establishing the character, identity and branding.

Function

- Vehicular safety
- Pedestrian scale comfort and safety
- Support night time activities
- Visual aesthetic
- Character, identity and branding of an area

General

- Where possible, reduce light pole heights to create more human scaled streetscapes.
- Lighting design should follow dark sky principles.
- Street lighting should meet the City's Engineering Design Criteria and Standard Drawings. Designers must consult an electrical engineering consultant to ensure adequate lighting levels and coverage.

Street Lighting

- Street light locations should be determined on a per project basis with an electrical engineering consultant.
- Street light poles should be approximately 6 – 7 m in height.

Pedestrian Lighting

- Pedestrian light locations should be determined on a per project basis in consultation with an electrical engineer.
- Pedestrian light poles should be approximately 4 – 5 m in height for better human scale.
- Pedestrian lighting should be located on streets with night time pedestrian activity including public spaces, restaurants, retail and entertainment.

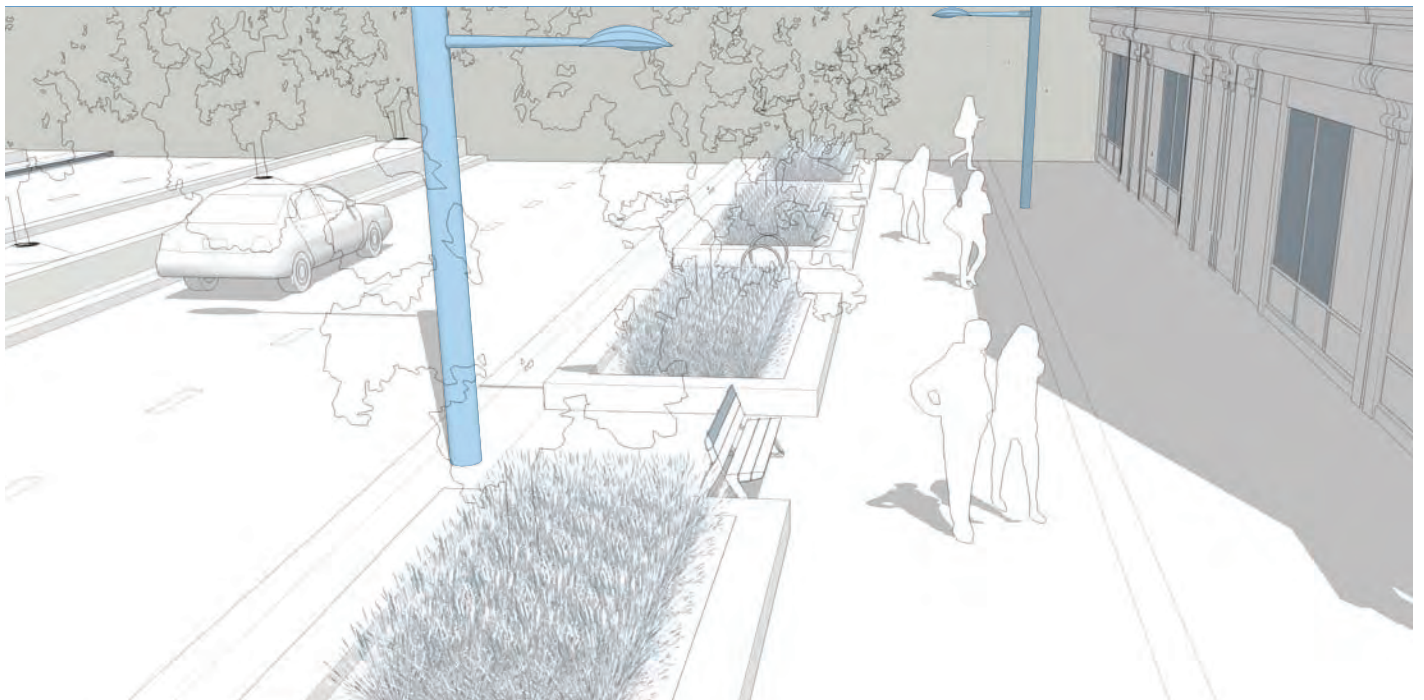

Figure 6.23: Illumination Elements

Standard Urban

KEY

— R.O.W

1. Standard Street Lighting

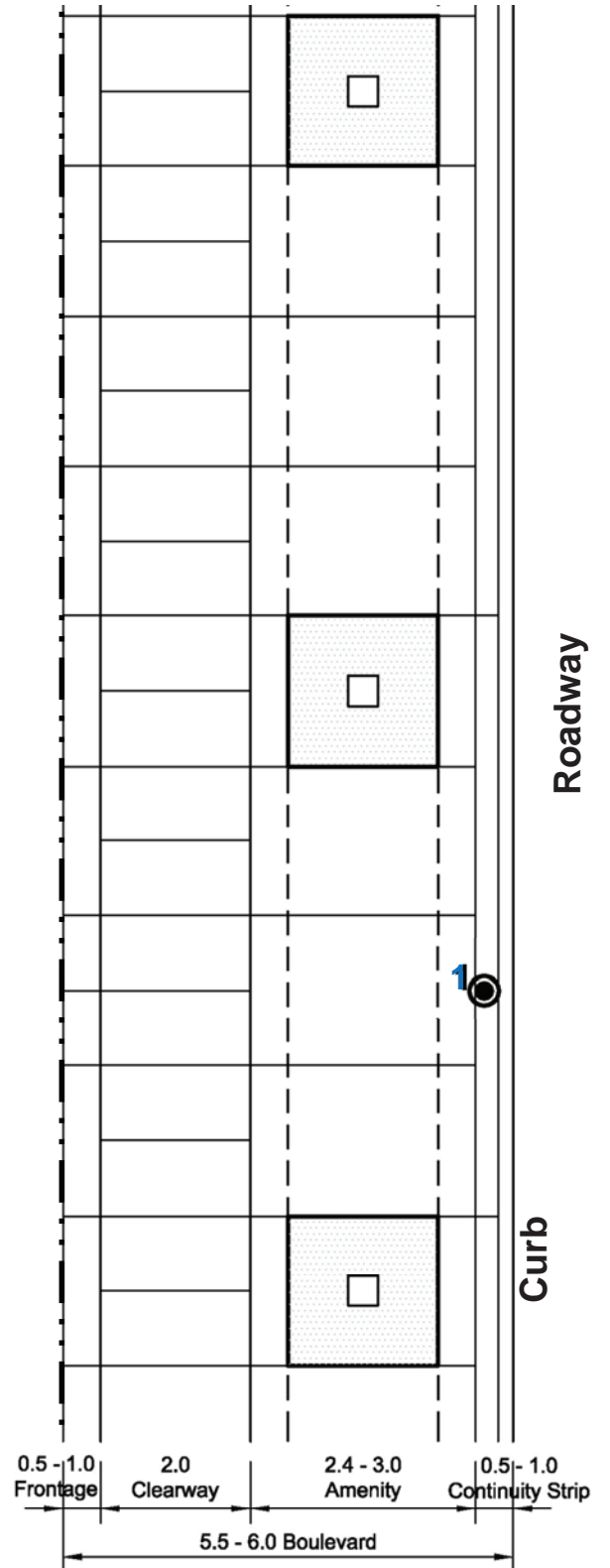
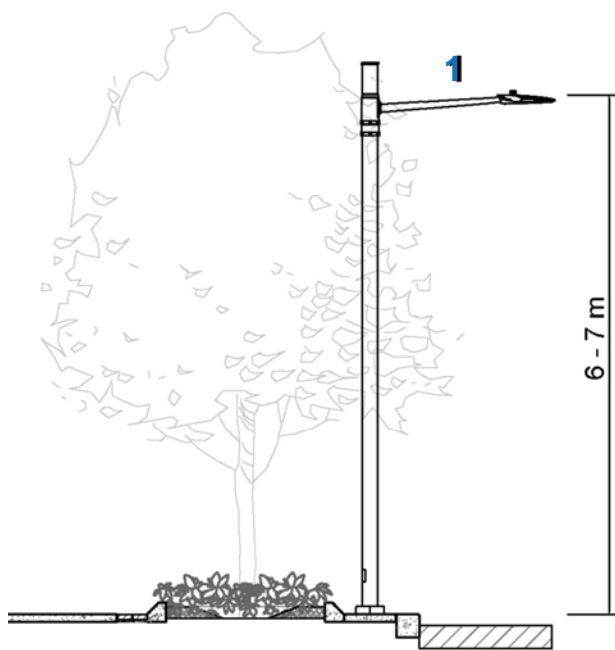

Enhanced

KEY

- R.O.W
- 1. Standard Lighting
 - Street Lighting
 - Pedestrian Lighting
 - Combined Street/ Pedestrian Lighting
 - Pedestrian Lighting only (on existing pole)
- 2. Standard Pedestrian Lighting to be located within ROW

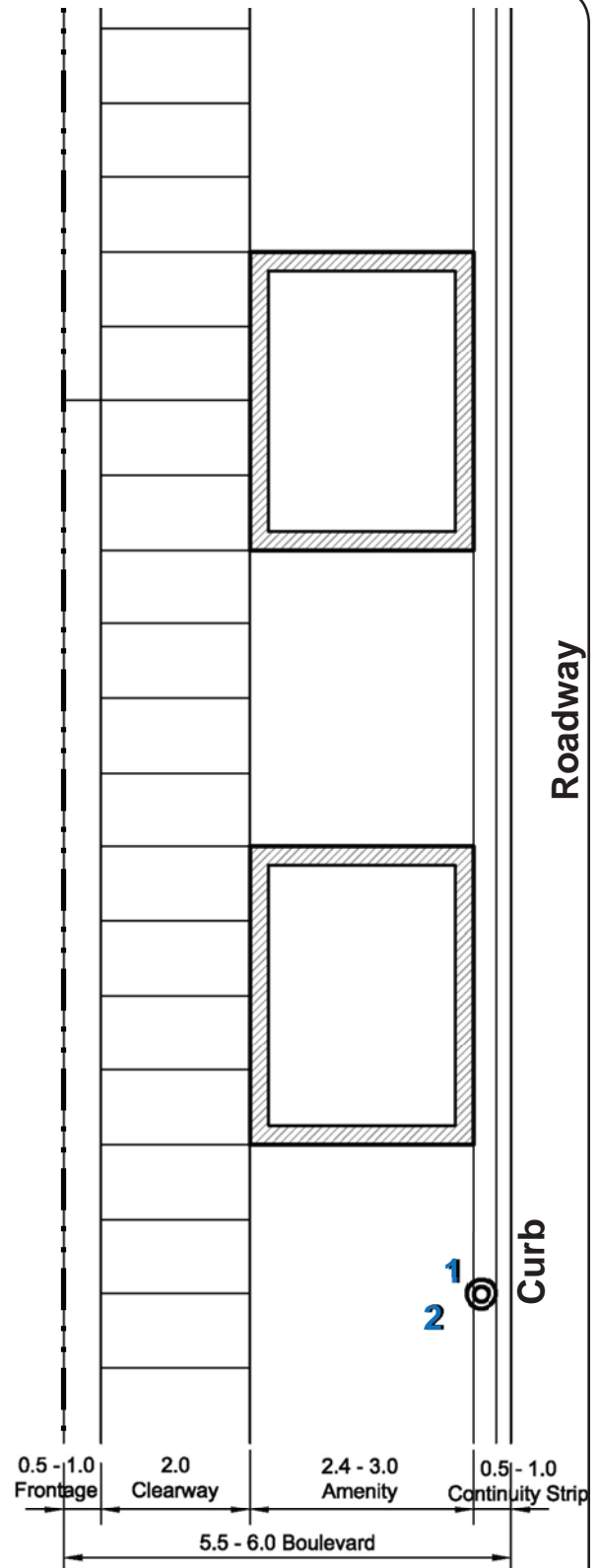
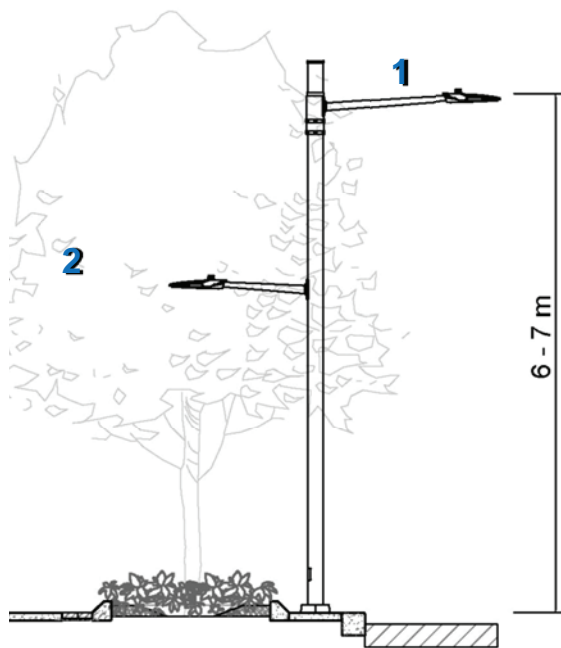

Premium

KEY

— R.O.W

1. Standard Lighting
 - Street Lighting
 - Pedestrian Lighting
 - Combined Street/ Pedestrian Lighting
 - Pedestrian Lighting only (on existing pole)
2. Standard Pedestrian Lighting to be located within ROW
3. Specialty
 - Bollard Lighting
 - Paving Lighting
 - Accent Lighting
 - Seatwall Lighting
 - Wall Wash Lighting

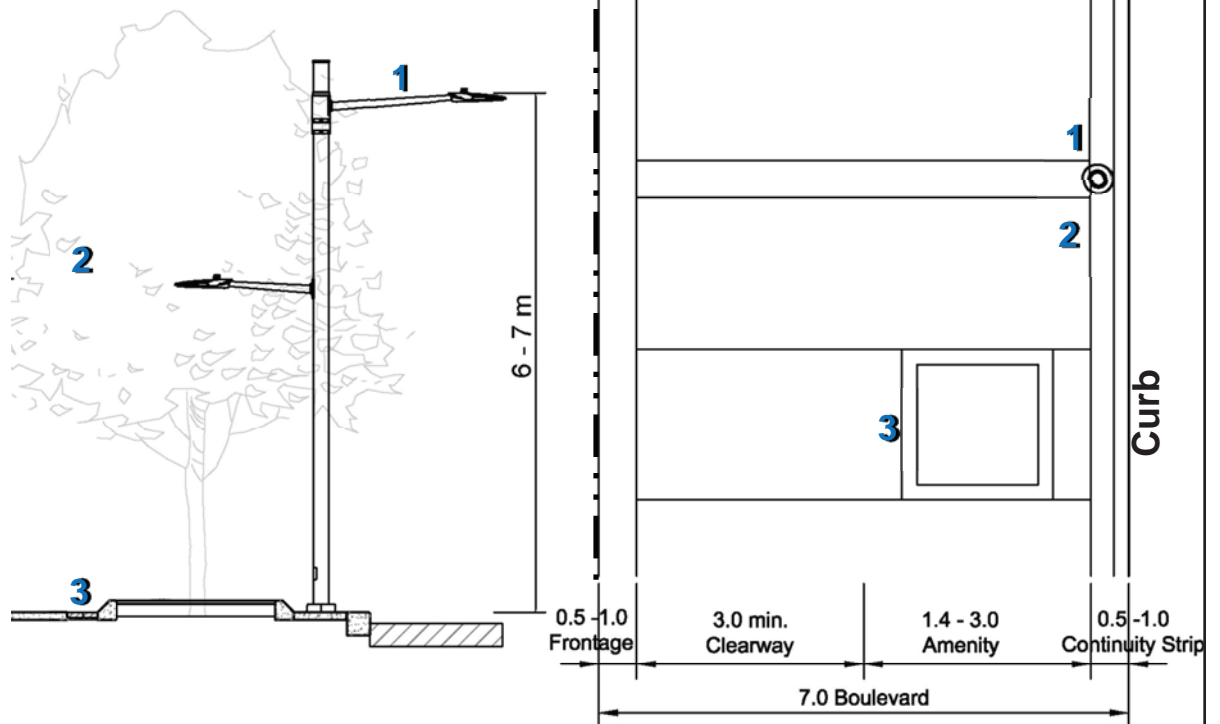

Planting

Planting in the form of trees, shrubs, perennials, ornamental grasses and ground cover provides visual aesthetics, protection from the elements, buffer zones, and ecosystem services. Planting is most often found in the amenity zone and occasionally the frontage zone.

Function

- Protection from the elements (sun, wind, rain, snow)
- Protection from urban elements (noise, vehicle exhaust)
- Create definition of space / semi-private barriers (vegetation between public and residential lands)
- Absorb water, soil and air contaminants
- Stormwater management and low impact development measures
- Visual aesthetic
- Character, identity and branding of an area

Biodiversity

- Planting species should be selected based upon best practices for specific site characteristics.
- Planting should reflect a diverse urban forest; a mix of compatible tree species shall be generally implemented within each street and neighbourhood. Tree species diversity should be selected to generate a consistent tree canopy, ie. tree species with similar growth rate, height and branching structure.

Special Planting

- Special planting could be used to distinguish special areas of cultural and historical significance including gateways, nodes and plazas.
- Special consideration should be given to planting used for low impact development measures along the streetscape.
- Annual or seasonal planting displays may be mobile in nature (i.e., movable planters) and able to relocate to best accommodate winter snow removal operations while ensuring the streetscape aesthetic and design intent are not compromised.

General Street Planting

- Planting shall generally be located in the amenity zone, acting as a buffer between vehicular traffic and the pedestrian clearway zone.
- Street planting must be coordinated with street furniture and above ground utilities. Where appropriate, open planters can be designed to incorporate seatwalls / benches.
- Locate curb and seat height planters in areas of fewer pedestrians for plant and tree protection from salt.
- Where required, passive and / or active irrigation shall be designed and installed. Drainage shall be provided for each planter as needed.
- Planting species should be selected appropriately to site conditions and have low maintenance requirements.

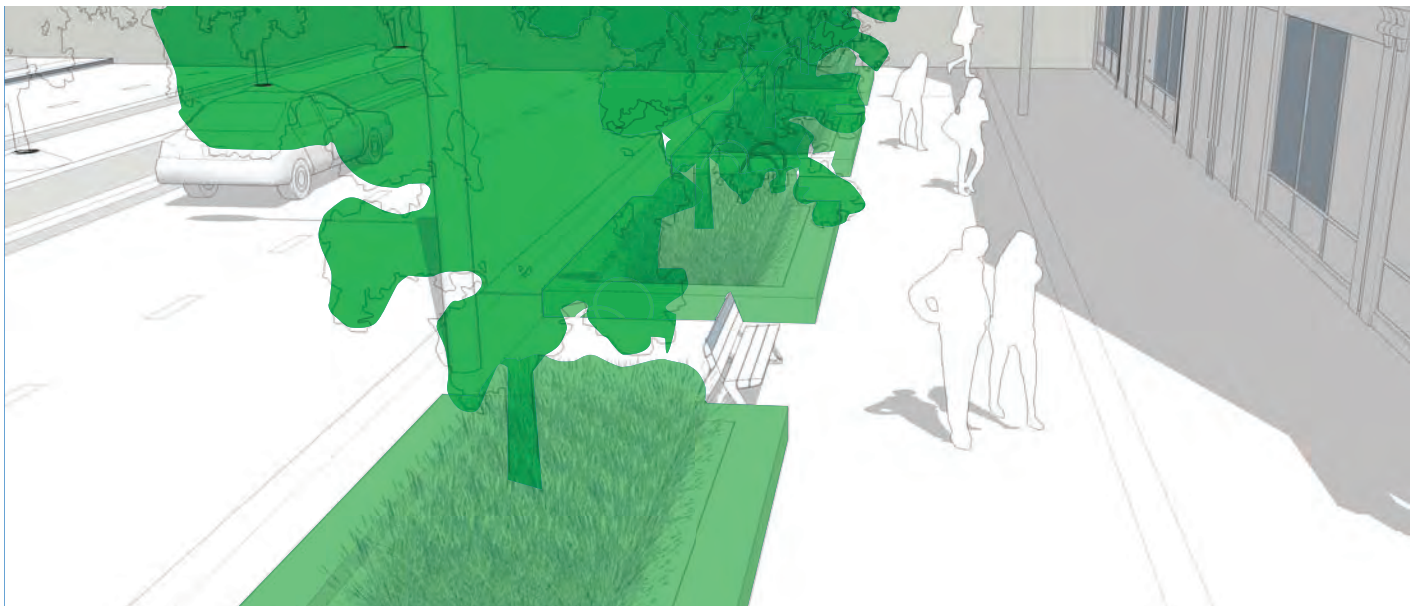

Figure 6.24: Planting

- Soil depths may vary depending on proposed planting material. Generally, tree soil in covered trenches must have an average of 1m depth of available soil; tree soil in open planters must have an average of 1.2m depth of available soil; shrubs and groundcover soil shall be determined per project.

Street Trees

- Street trees should be planted approximately 6 - 10 m on centre, depending on tree canopy size, to ensure adequate continuous tree pit soil volumes and a continuous protection from the elements for pedestrians depending on expected canopy maturity.
- Street trees should be planted a minimum of 2 m from the curb line (ideally 2.5 - 3.0 m) to the centre of the tree trunk.
- Allow for sufficient tree canopy allowance to ensure unencumbered canopy growth from buildings and other sidewalk elements.
- Street trees should have minimum 16 m³ of soil volume per tree with a direct access to an additional 14 m³ for a total soil volume of 30 m³.
- Tree grates shall be used in areas of high pedestrian traffic and volumes such as nodes, intersections and other urban areas.
- Introduce structural soil cells in areas of high pedestrian traffic to protect tree roots soil volumes.
- Tree planting must be thoroughly coordinated with infrastructure and utilities located above and below ground.
- No public utilities should be located under street trees to avoid root conflicts.
- Street tree rhythm may vary between mid-block conditions and the transition zone of intersections.
- Where double rows of trees are contemplated, tree planters must be a minimum of 2 m in width.
- Lists of approved street tree species for streetscapes are available for Vaughan and York Region. Designers should consult the lists to select appropriate street trees (see Appendix B,C and D).
- Tree planting opening details shall be determined by the amount of pedestrian traffic flow expected within each sidewalk. In general, where a large volume of pedestrians is expected, the tree opening may be reduced to a minimum of 1.5 m x 1.5 m or (1.5 m diameter); where the pedestrian volume is expected to be minor, larger tree openings (open planters) can be designed (maximum up to two trees per planter).



Standard Urban

KEY

- — R.O.W
- 1. Tree Planting
 - 60mm Caliper for Deciduous
- 2. Planting Area /Softscape
 - Planting Soil
 - Tree Grate
 - Mulch
 - Perennials and Ornamental Grasses
 - Deciduous Shrub 0.6m Height
 - Coniferous Shrub 0.6m Height
- 3. Continuous Planting Trench Below

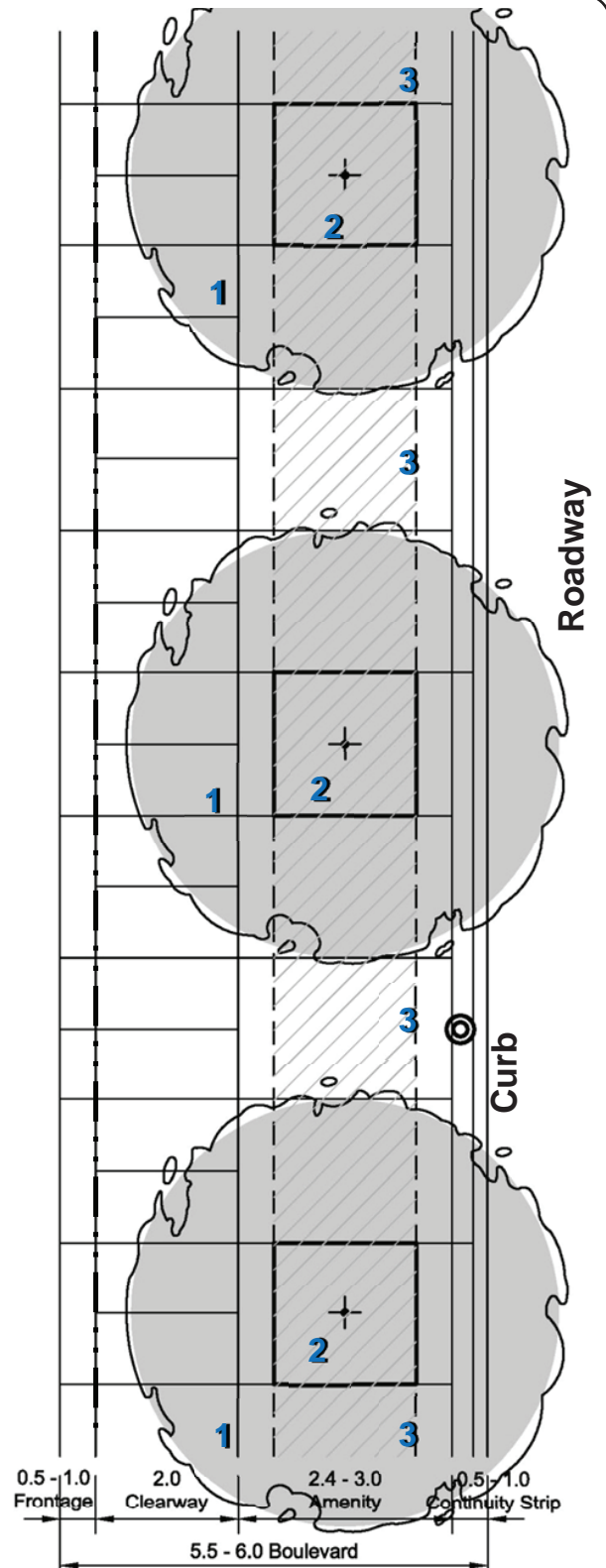

Enhanced

KEY

- R.O.W
- 1. Tree Planting
 - 60mm - 80mm Caliper for Deciduous
- 2. Planting Area /Softscape
 - Planting Bed
 - Mulch
 - Perennials and Ornamental Grasses
 - Deciduous Shrub 1.0 to 1.5m Height
 - Coniferous Shrub 0.6m Height
- 3. Continuous Planting Trench Below
- 4. Planter
 - Flush Planter Curb
 - Raised Planter Curb
 - Free-standing Planter

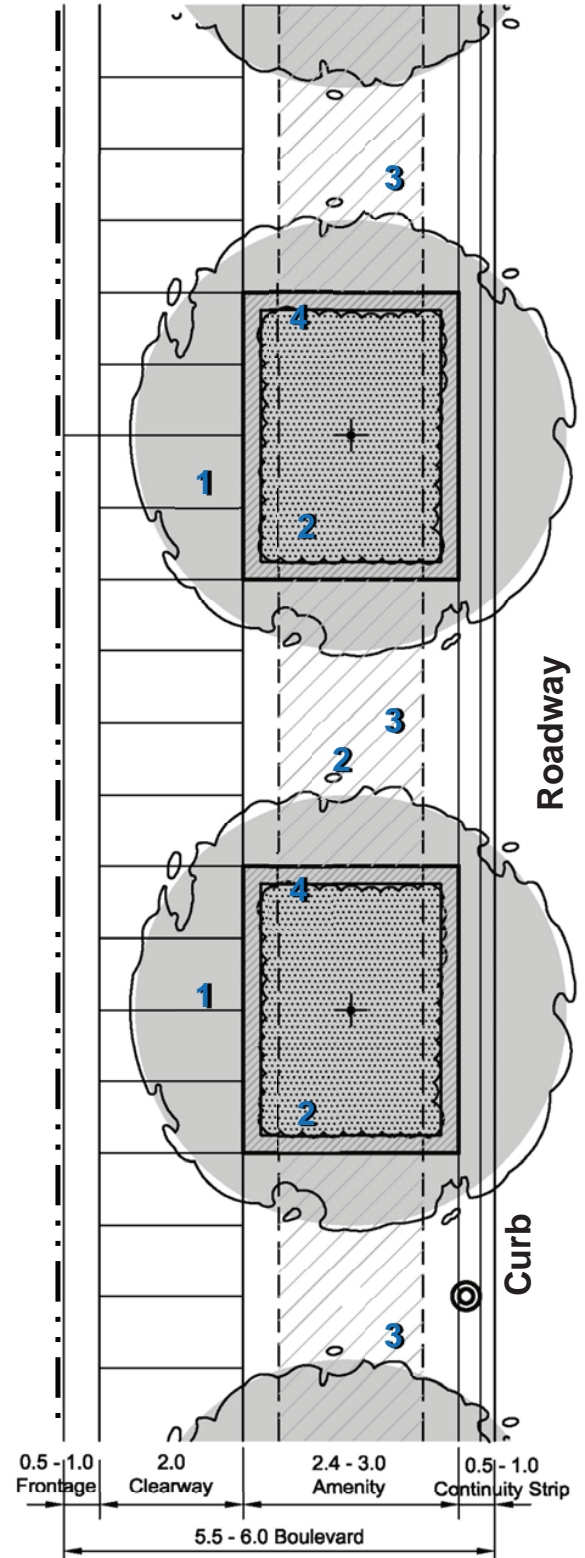

Enhanced Double Row of Trees (Green Streets)

KEY

- — R.O.W
- 1. Tree Planting
 - 60mm - 80mm Caliper for Deciduous
- 2. Planting Area /Softscape
 - Planting Bed
 - Mulch
 - Perennials and Ornamental Grasses
 - Deciduous Shrub 1.0 to 1.5m Height
 - Coniferous Shrub 0.6m Height
- 3. Continuous Planting Trench Below
- 4. Planter
 - Flush Planter Curb
 - Raised Planter Curb
 - Free-standing Planter
- 5. Structural Soil Cells (16 m³ min. vol. per tree with access to an additional 14 m³ for 30m³ total)

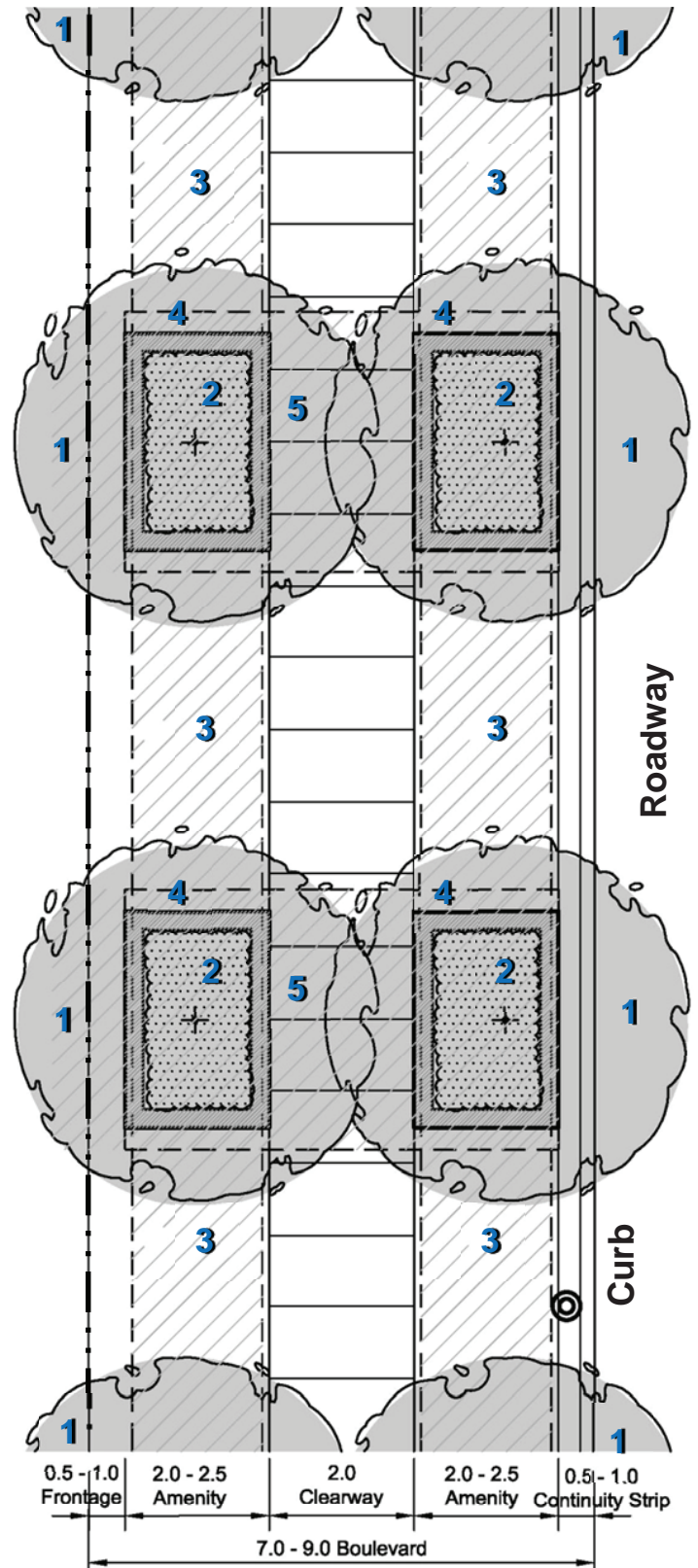

Note: Enhanced level of service streetscapes with a double row of trees in the public right-of-way requires a minimum of 2.0 meter wide planters and 2.0 meter pedestrian clearway. Where a double row of trees does not fit in the public row, consider negotiations with private land owners to plant a row of trees in the private setback.

Premium

KEY

- — R.O.W
- 1. Tree Planting
 - 60mm - 100mm Caliper for Deciduous
- 2. Planting Area /Softscape
 - Planting Soil
 - Tree Grate
 - Mulch
 - Perennials and Ornamental Grasses
 - Deciduous Shrub 1.0 to 1.5m Height
 - Coniferous Shrub 0.6m Height
- 3. Structural Soil Cells (16 m³ min. vol. per tree with access to an additional 14 m³ for 30m³ total)
- 4. Planter
 - Flush Planter Curb
 - Raised Planter Curb
 - Seatwall Planter (@0.45m ht.)
 - Free Standing Planter
- 5. Continuous Planting Trench Below

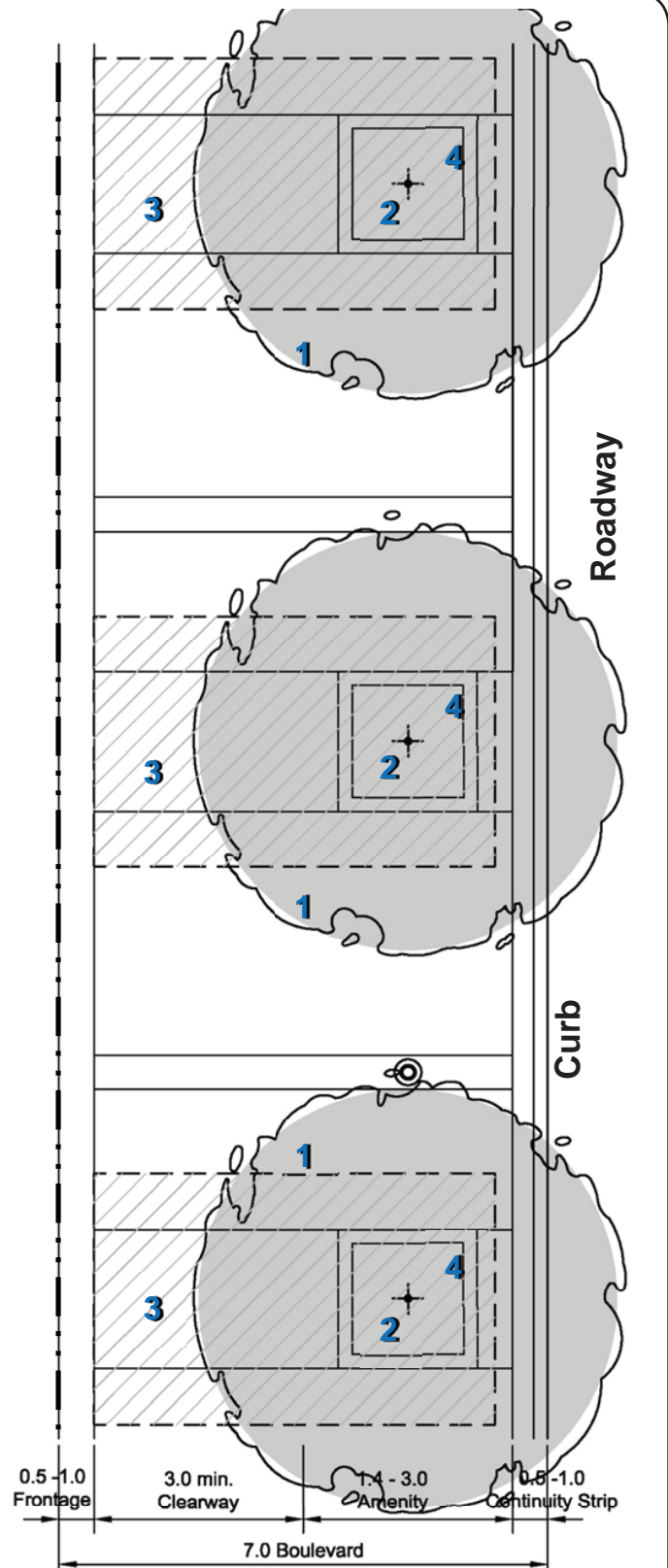

Premium Double Row of Trees (Green Streets)

KEY

- — R.O.W
- 1. Tree Planting
 - 60mm - 100mm Caliper for Deciduous
- 2. Planting Area /Softscape
 - Planting Soil
 - Tree Grate
 - Mulch
 - Perennials and Ornamental Grasses
 - Deciduous Shrub 1.0 to 1.5m Height
 - Coniferous Shrub 0.6m Height
- 3. Structural Soil Cells (16 m³ min. vol. per tree with access to an additional 14 m³ for 30m³ total)
- 4. Planter
 - Flush Planter Curb
 - Raised Planter Curb
 - Seatwall Planter (@0.45m ht.)
 - Free Standing Planter
- 5. Continuous Planting Trench Below

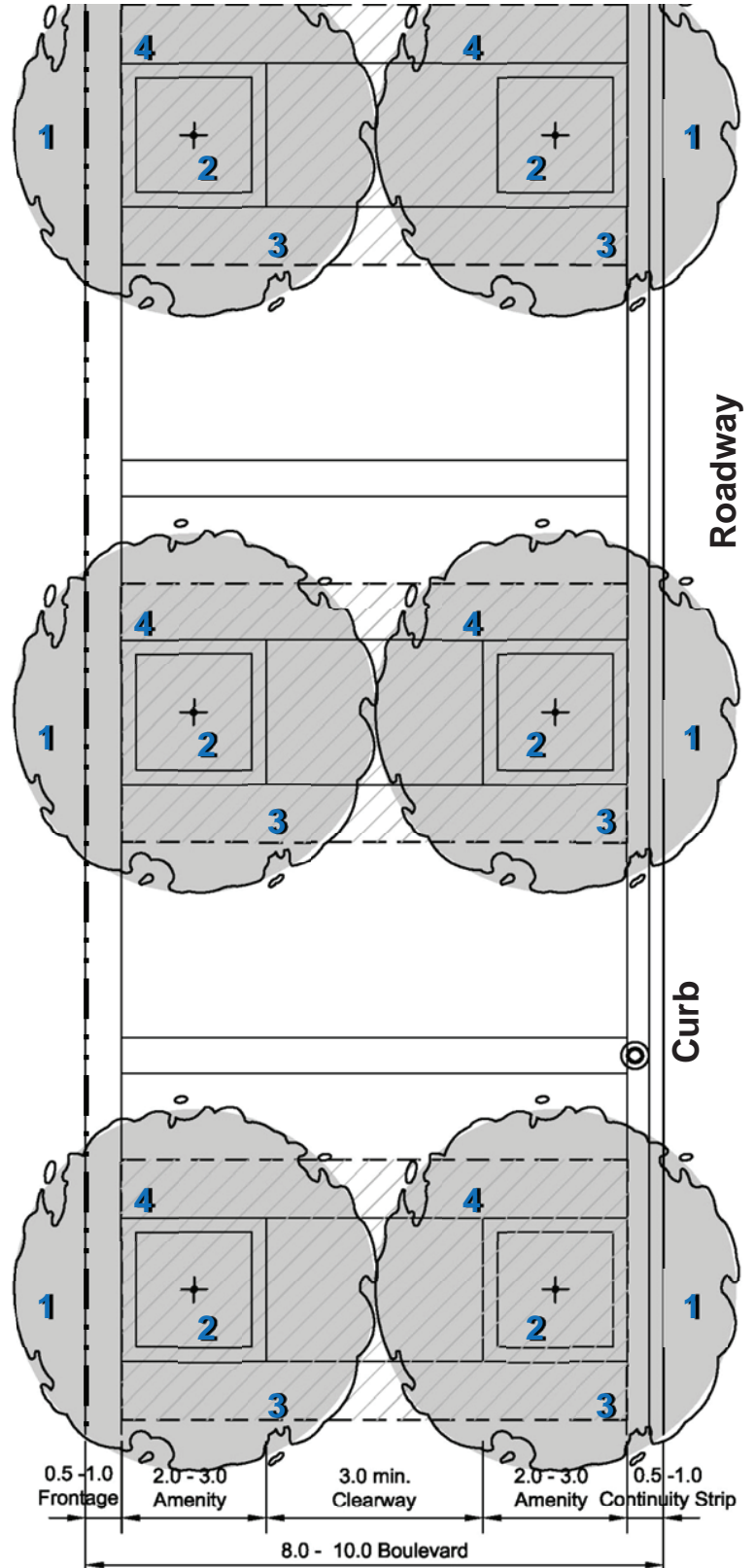

Note: Premium level of service streetscapes with a double row of trees in the public right-of-way requires a minimum of 2.0 meter wide planters and 3.0 meter pedestrian clearway. Where a double row of trees does not fit in the public row, consider negotiations with private land owners to plant a row of trees in the private setback.

Site Furnishings

Site furnishings act as a unifying element along the length of a streetscape. The combination of style, texture and colour convey a visual connection between areas and contribute to each area's individual identity. Site furnishings are often grouped intermittently and become subtle reminders of an area's theme.

Function

- Pedestrian amenity
- Support active transportation
- Character, identity and branding of an area

General Guidelines

- Site furnishings to be located in the amenity zone and not interfere with the pedestrian clearway zone.
- Site furnishings to be clustered and located in strategic locations to avoid visual clutter and most efficiently serve pedestrians. Locations include nodes, pedestrian trails, cycling amenities for cycling routes, rest points and bus stops.
- Site furnishings should be durable, vandal-resistant, replaceable and easily maintainable.
- Site furnishings should be comfortable and accessible for all seasons.
- Site furnishings should be selected collectively to ensure a consistent character and design.

Waste and Recycling Receptacles

- Receptacles should be two stream.
- Effort should be made to consider solar powered compactors, such as 'Big Belly Solar', in the future.

Benches

- Benches should be minimum of 1.5 m in length to comfortably seat 2 to 3 individuals.

Bollards

- Removable or drop down bollards should be located at strategic locations for bus, emergency or service functions.
- Bollards should be of durable finish with concealed mounting.

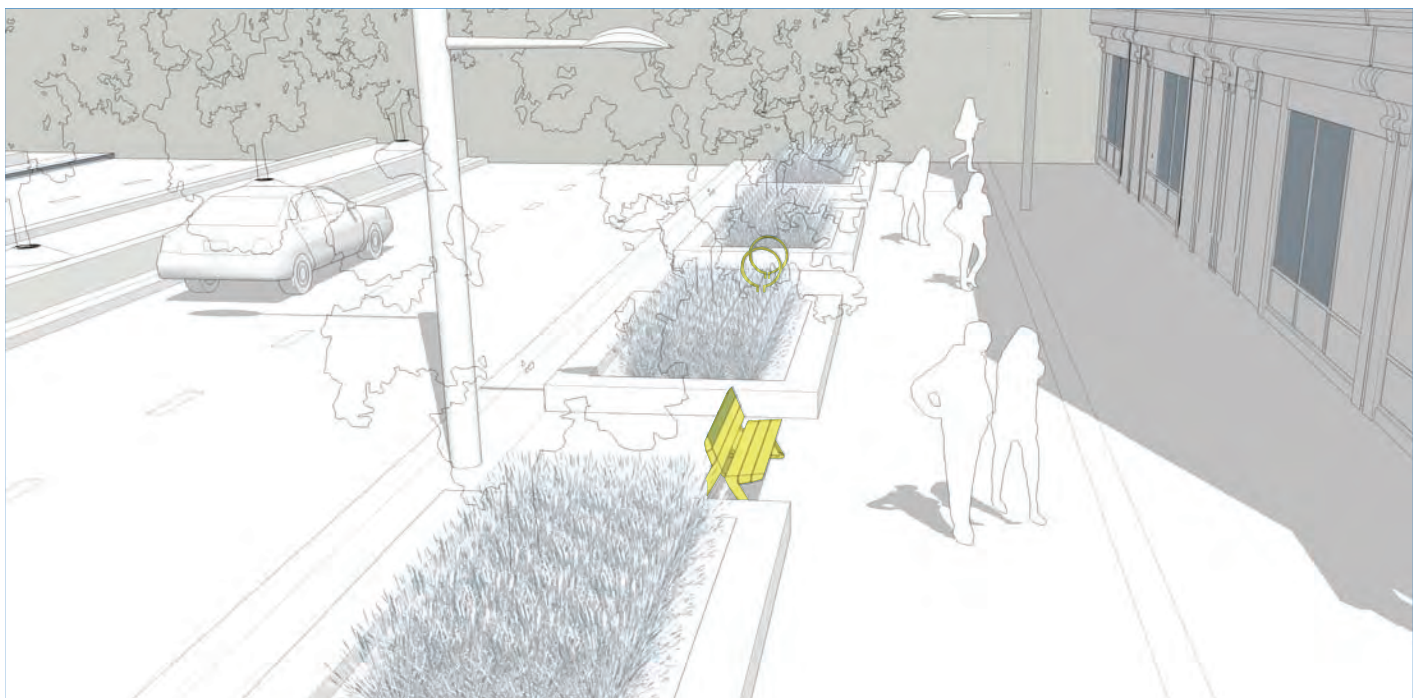

Figure 6.25: Site Furnishings

Bicycle Parking

- Bicycle stands should be located at key nodes, destinations and streets that are part of the transit and cycling networks including park entrances, schools, civic and community buildings, key shopping areas and transportation hubs.
- Bicycle stands shall be located close to building entrances without interrupting with pedestrian flow.
- Where possible, bicycle stands shall be located in a sheltered area for protection from elements.
- Bicycle stands shall be durable.
- Provide 0.75 m between each single bicycle stand.
- Provide 0.5 m between bicycle stands and the clearway (when parallel to the clearway)
- Provide 0.5 m between bicycle stands and planter/ planting (when parallel to planter/planting)
- Provide 0.5 - 0.7 m between bicycle stands and the curb with no on-street parking (when parallel to curb)
- Provide 1.0 - 1.3 m between bicycle stands and the curb with on-street parking (when parallel to curb).
- Bicycle stands shall be installed on hardscape.
- Provide a concrete pad adjacent to the pedestrian clearway zone for bicycle stands where no hardscape for installation is available.
- Bicycle stands shall be powder coated and embedded with concrete footing.

Enhanced

KEY

— R.O.W

1. Bench

2. Waste Receptacle / Recycle Unit

3. Bicycle Parking

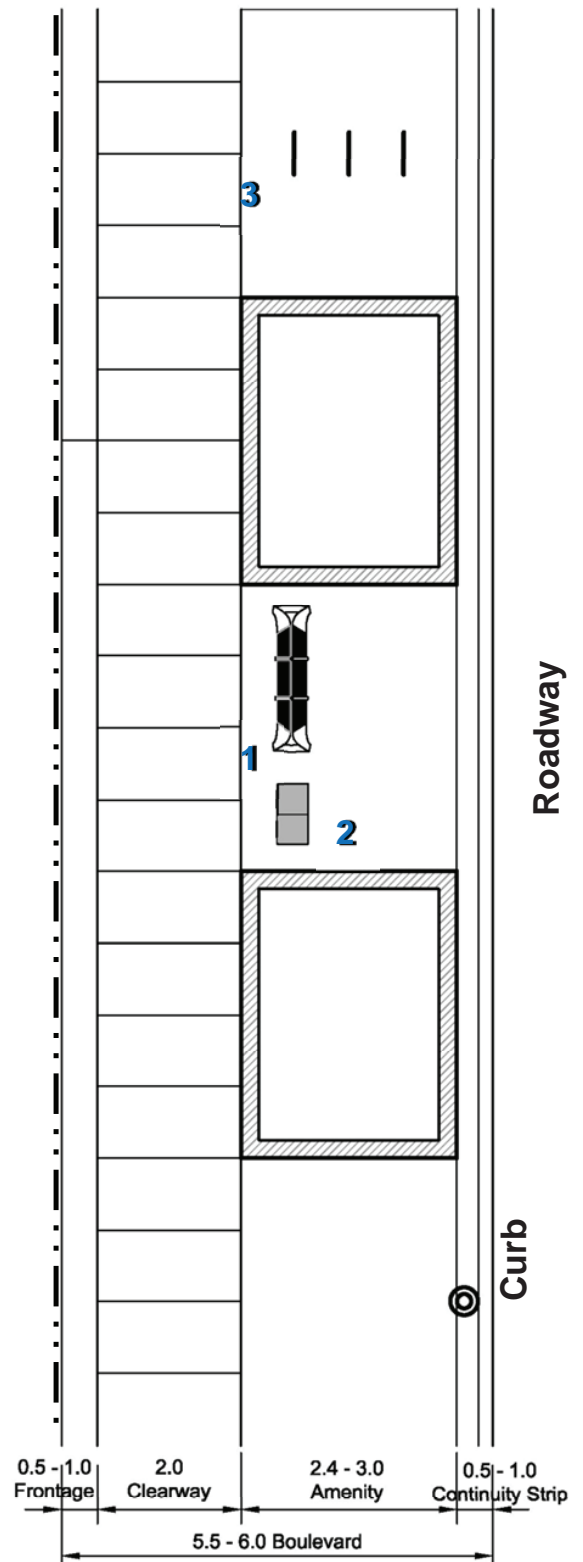

Note: Locations of site furnishings for illustration purposes only. Site Furnishings to be located per design and best practice.

Premium

KEY

- R.O.W
- 1. Bench
- 2. Waste Receptacle / Recycle Unit
- 3. Bicycle Parking

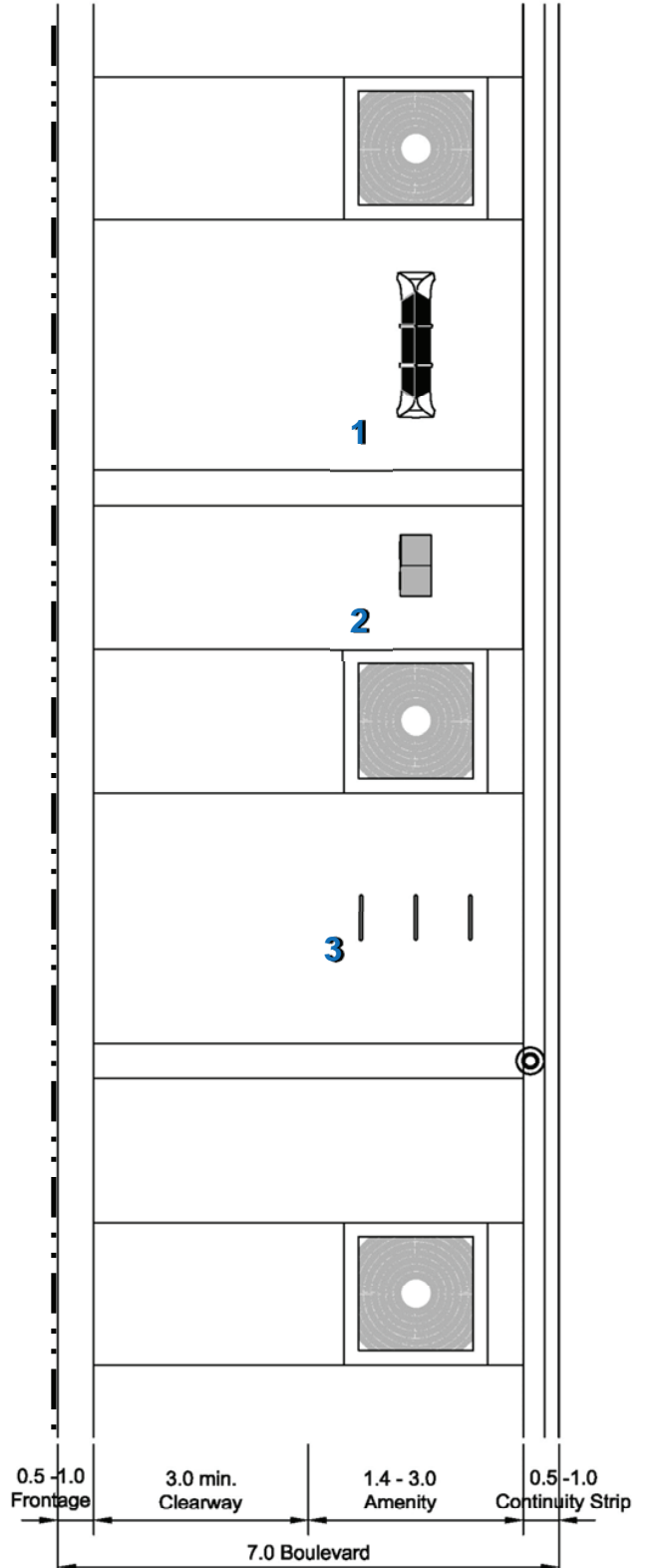

Note: Locations of site furnishings for illustration purposes only. Site Furnishings to be located per design and best practice.

Medians

The role of a median is more important to vehicular roadway functions; however, medians offer space for a variety of elements which contribute to the visual interest and aesthetic of an area. Medians also provide a refuge for pedestrians crossing large roadways at intersections.

Function

- Separate opposite directions of vehicular traffic.
- Pedestrian refuge for pedestrian crossings greater than 15 m in length.
- Space for visual aesthetic elements such as planting and public art.
- Space for character, identity, branding elements.

General Guidelines

- No planting or visual obstructions should be located past the pedestrian crossing into the intersection.
- A continuous splash pad should be located on both sides of the median where the median is large enough for planting.

Pedestrian Crossing

- The median should provide clear access with no obstructions where pedestrian crossings cross the median.
- AODA ramps or drop curbs with tactile surface should be provided where pedestrian crossings cross the median.

Vegetation

- Where trees or planting is located in the median, a raised planter curb protects vegetation from road salt.
- Shrubs, perennials and ornamental grasses used in the median should not obstruct sight lines near intersections.
- Where planting is included in the median, the median should have a minimum width of 4 m for shrub and ornamental planting and a minimum width of 6 m for tree planting.
- Automated irrigation to be considered in planted medians for ease of maintenance.
- Planting in the median should be salt and drought tolerant for greatest success of survival (see Appendix E for Salt and Drought Tolerant Species List).

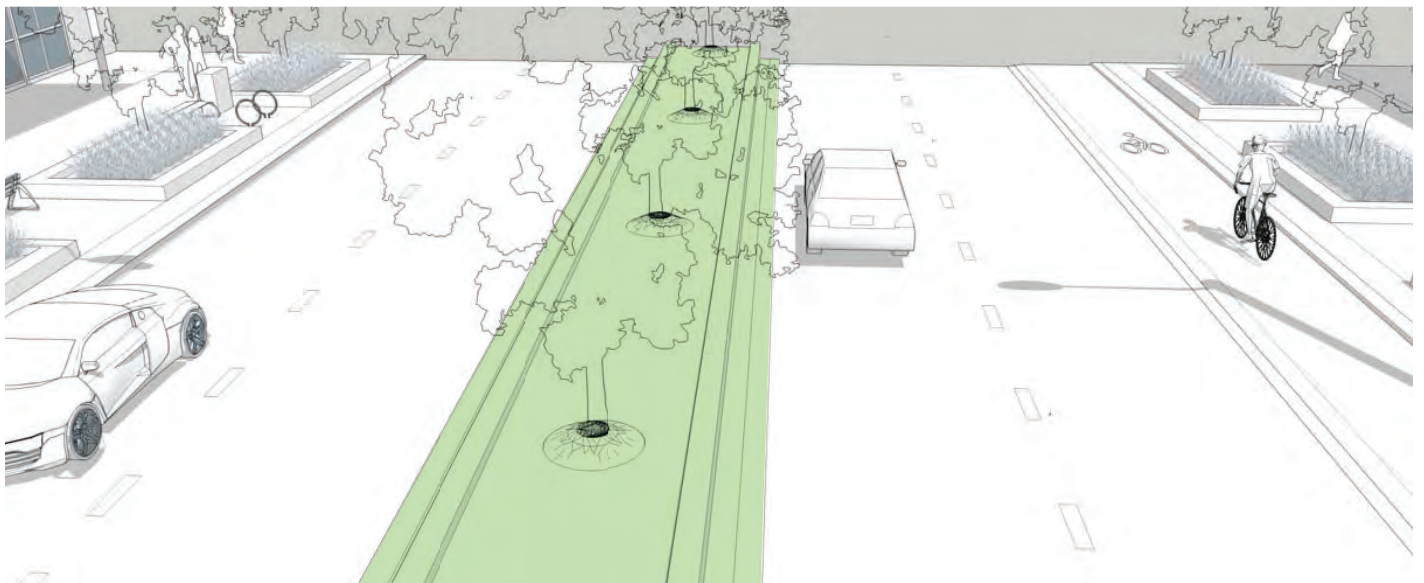
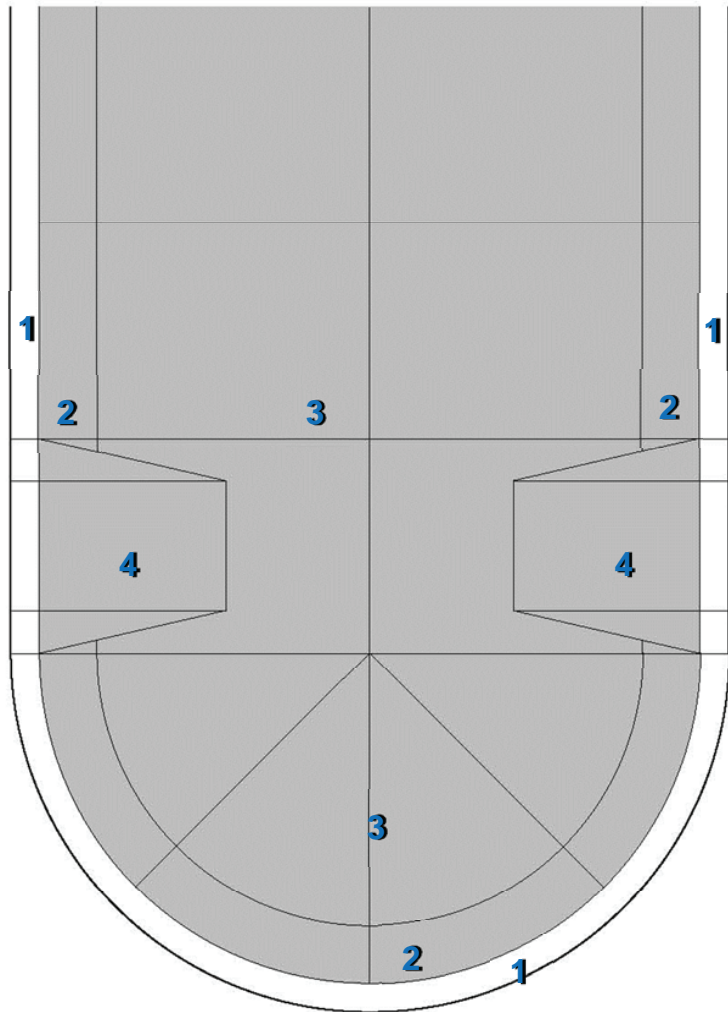

Figure 6.26: Medians

Standard Urban Hardscape

KEY

- 1. P.I.P Concrete Curb
- 2. P.I.P Concrete Continuity Strip
- 3. P.I.P Concrete Paving
- 4. AODA Ramp and Drop Curb



PLAN

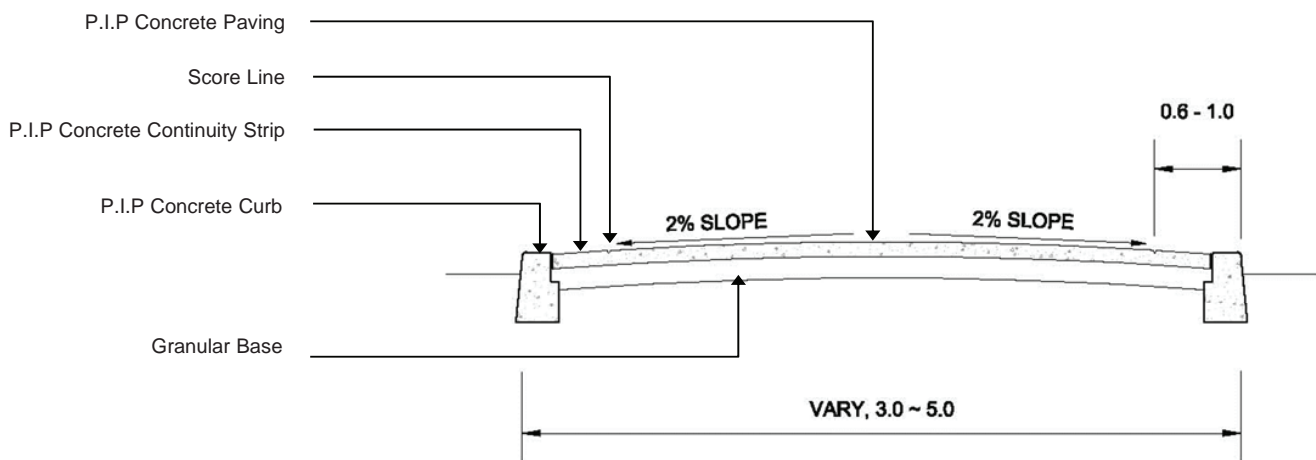

SECTION

Enhanced Hardscape

KEY

- 1. P.I.P Concrete Curb
- 2. Continuity Strip
Material Options:
P.I.P concrete Paving
Pre-cast Concrete Unit Paver
Permeable Paving
- 3. Field Paving
Material Options:
P.I.P concrete Paving
Pre-cast Concrete Unit Paver
Permeable Paving
- 4. AODA Ramp and Drop Curb

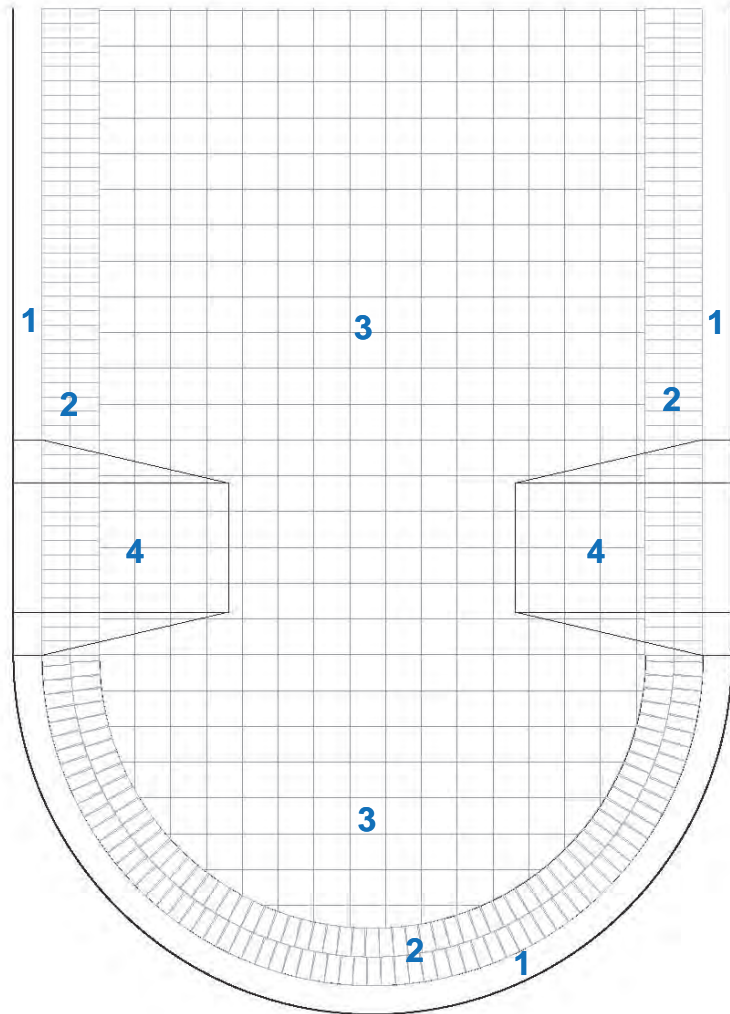

PLAN

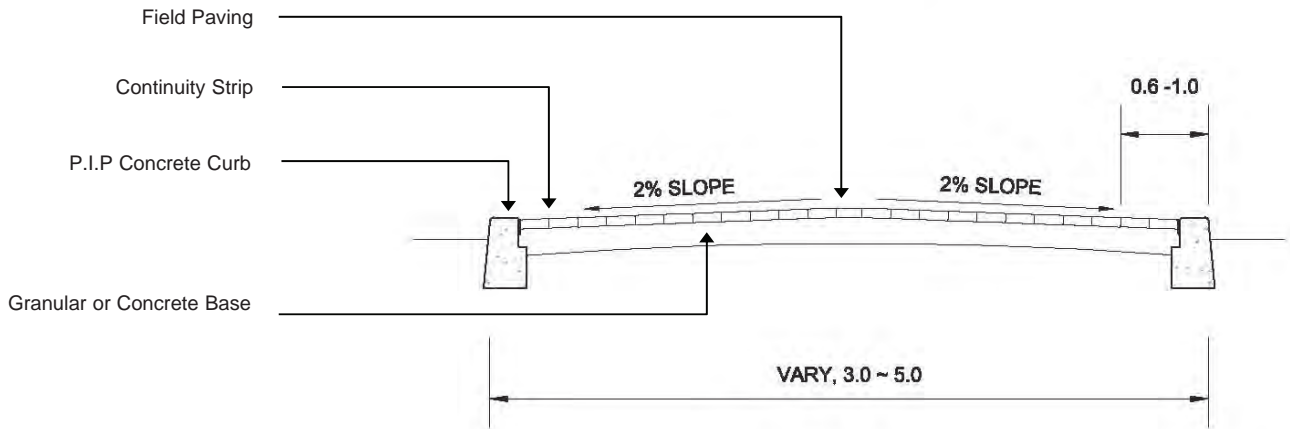

SECTION

Premium Hardscape

KEY

- 1. P.I.P Concrete Curb
- 2. Continuity Strip
Material Options:
P.I.P concrete Paving
Pre-cast Concrete Unit Paver
Natural Stone Paver
Permeable Paving
- 3. Field Paving
Material Options:
P.I.P concrete Paving
Pre-cast Concrete Unit Paver
Natural Stone Paver
Permeable Paving
- 4. AODA Ramp and Drop Curb

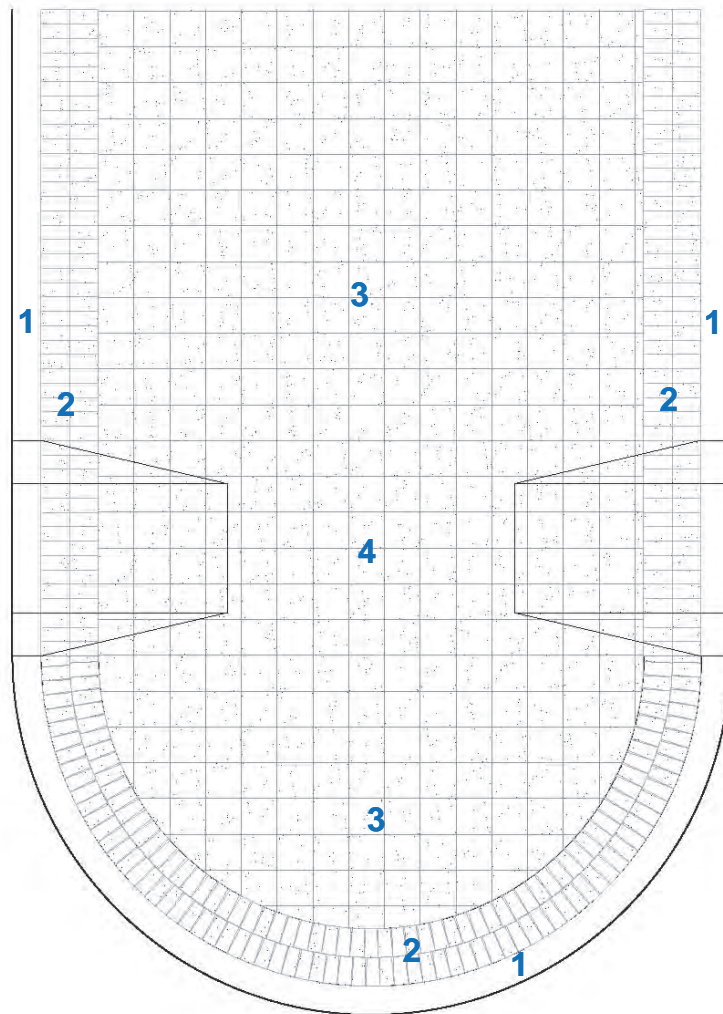

PLAN

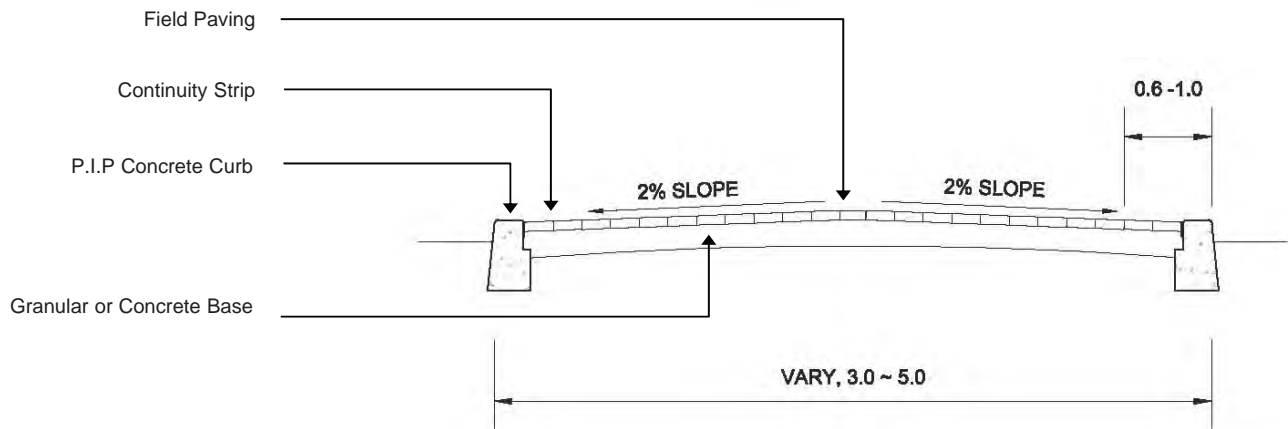

SECTION

Standard Urban Softscape

KEY

- 1. P.I.P Concrete Curb
- 2. P.I.P Concrete Continuity Strip
- 3. P.I.P Concrete Paving
- 4. AODA Ramp and Drop Curb
- 5. P.I.P Concrete Planter Curb 200x200mm Min.
- 6. Tree Planting
60mm Caliper for Deciduous
2.0m Height for coniferous
- 7. Softscape
Sod
Mulch
Perennials
Ornamental Grass
Deciduous Shrub 600mm Height
Coniferous Shrub 600mm Height

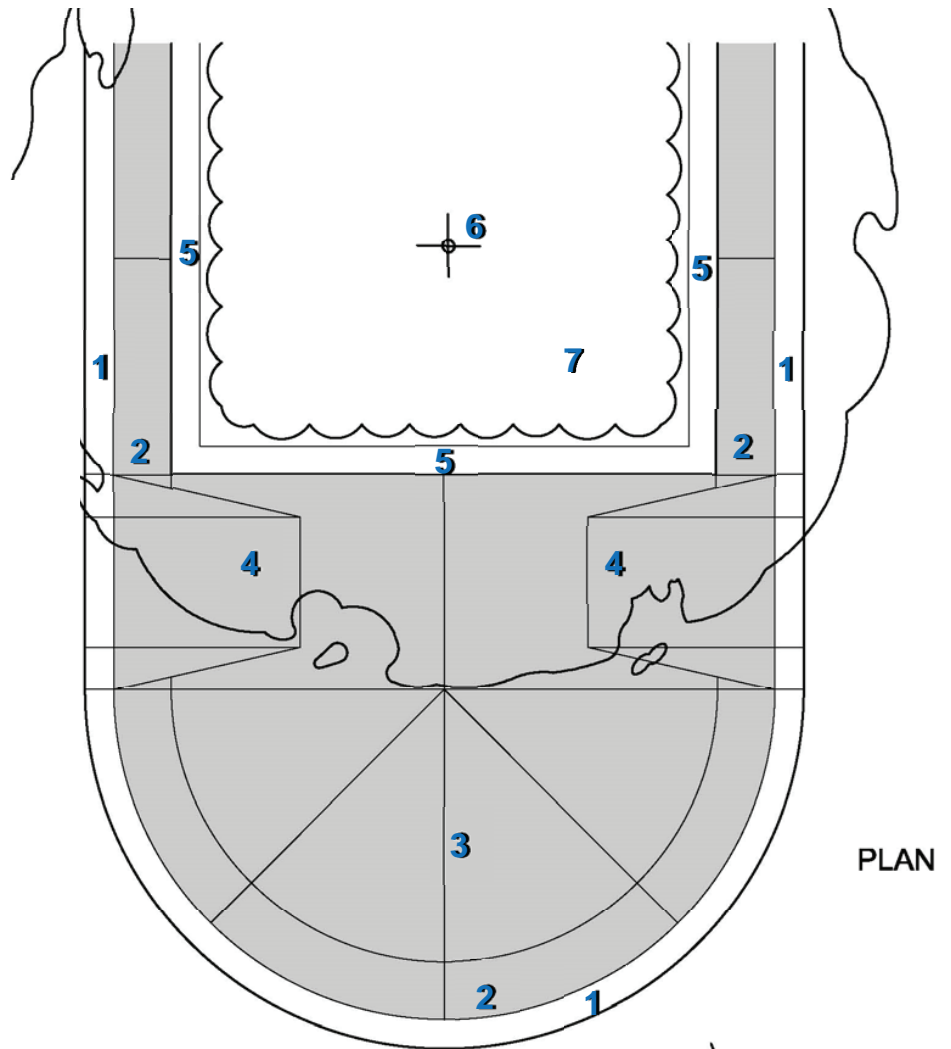

PLAN

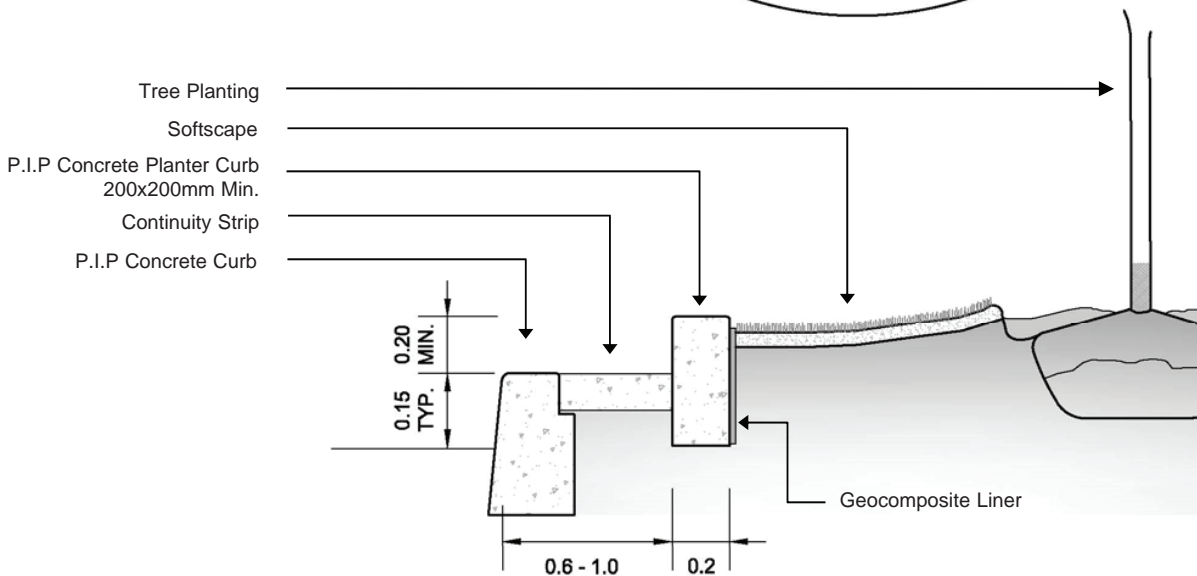

SECTION

Enhanced Softscape

KEY

- 1. P.I.P Concrete Curb
- 2. Continuity Strip
Material Options:
P.I.P concrete Paving
Pre-cast Concrete Unit Paver
Permeable Paving
- 3. Field Paving
Material Options:
P.I.P concrete Paving
Pre-cast Concrete Unit Paver
Permeable Paving
- 4. AODA Ramp and Drop Curb
- 5. P.I.P Concrete Planter Curb
200x200mm Min.
- 6. Tree Planting
60-80mm Caliper for Deciduous
2.0-2.5m Height for coniferous
- 7. Softscape
Sod
Mulch
Perennials
Ornamental Grass
Deciduous Shrub 600mm-1500mm Height
Coniferous Shrub 600mm Height

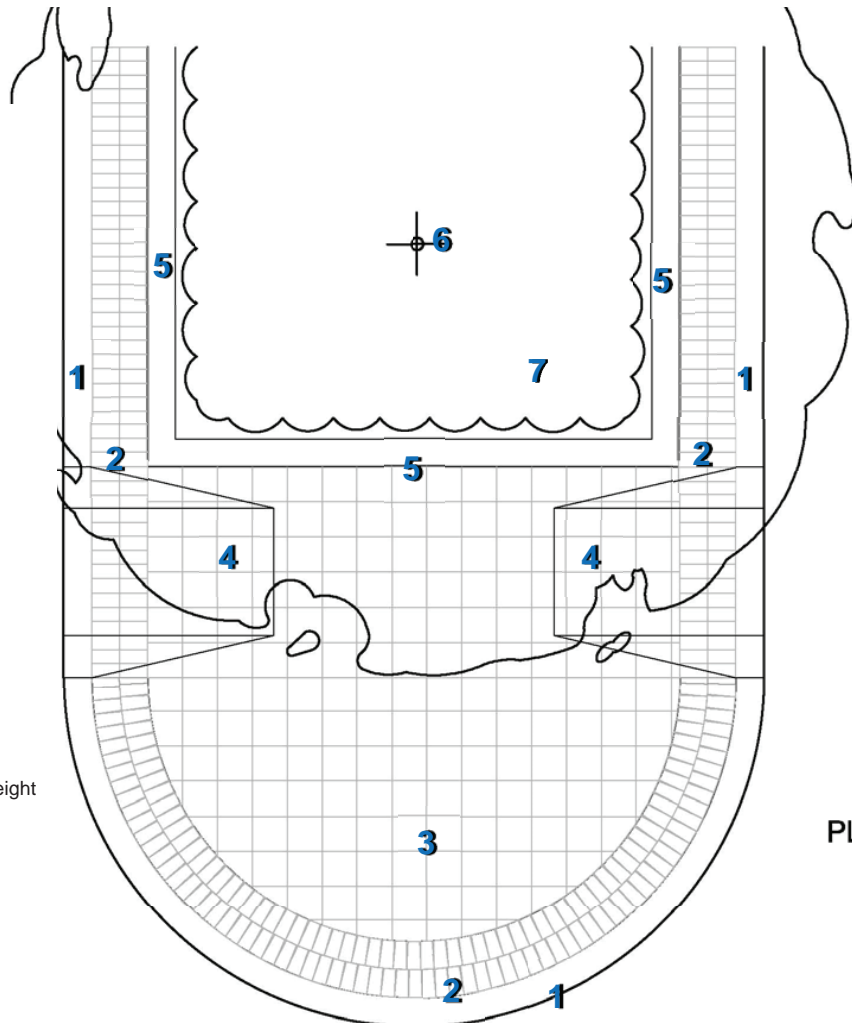

PLAN

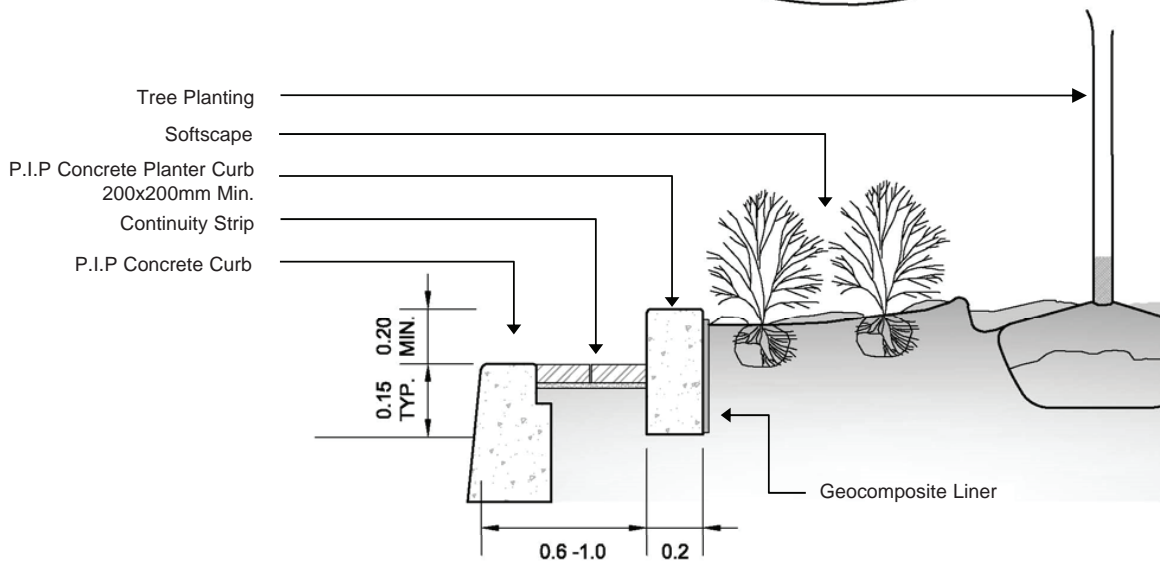

SECTION

Premium Softscape

KEY

1. P.I.P Concrete Curb
2. Continuity Strip
Material Options:
P.I.P concrete Paving
Pre-cast Concrete Unit Paver
Natural Stone Paver
Permeable Paving
3. Field Paving
Material Options:
P.I.P concrete Paving
Pre-cast Concrete Unit Paver
Natural Stone Paver
Permeable Paving
4. AODA Ramp and Drop Curb
5. P.I.P Concrete Planter Curb
200x200mm Min.
6. Tree Planting
60-100mm Caliper for Deciduous
2.0-3.0m Height for coniferous
7. Softscape
Sod
Mulch
Perennials
Ornamental Grass
Deciduous Shrub 600mm-1500mm Height
Coniferous Shrub 600mm Height
8. 450mm Seatwall Planter Curb

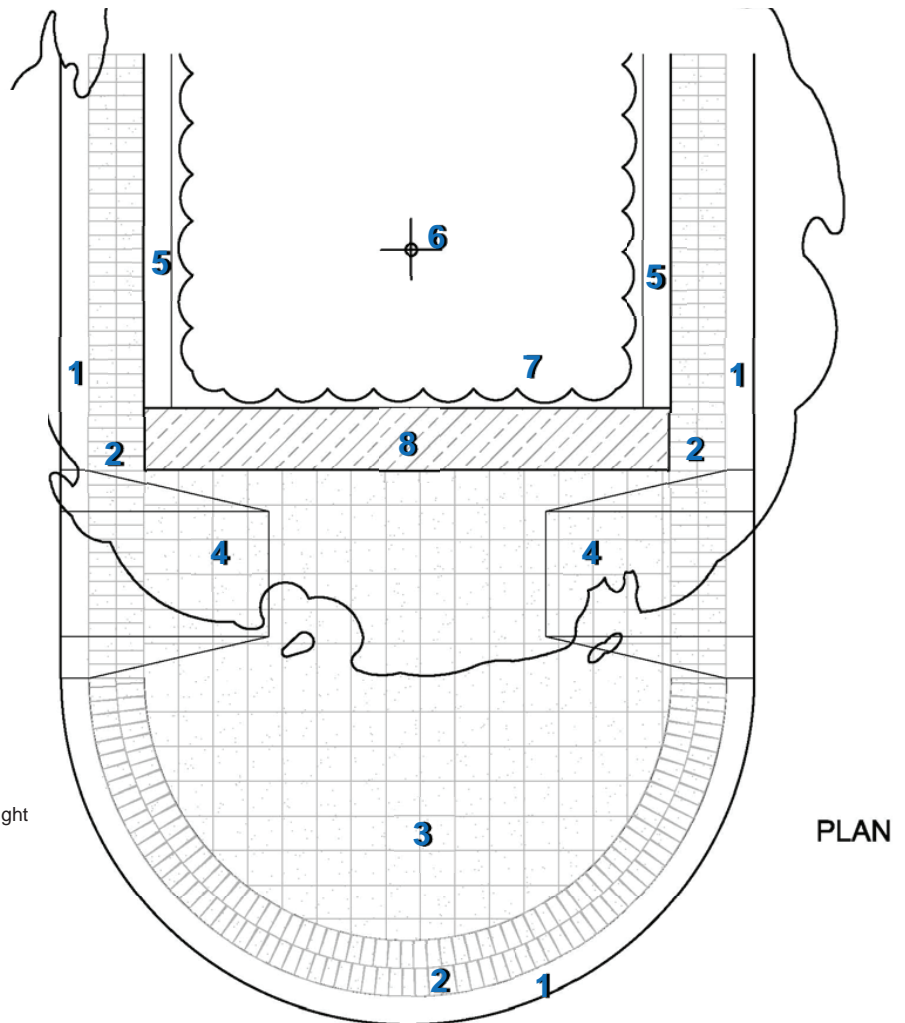

PLAN

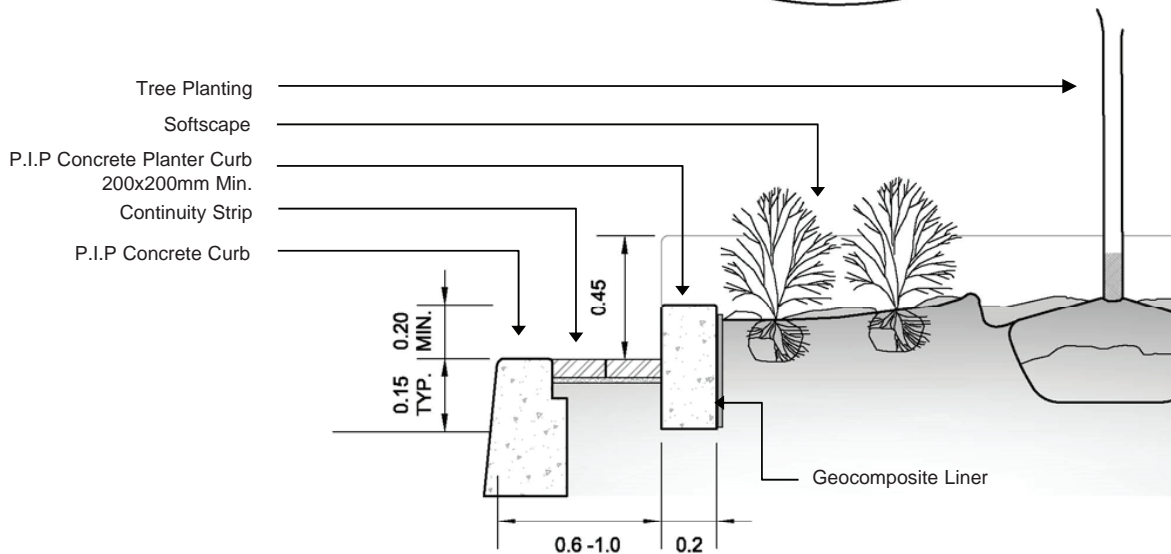

SECTION

Intersections

Intersections are locations where the paths of perpendicular roadways cross. At the intersection, vehicles, pedestrians and cyclists come into direct interaction. Pedestrians and cyclists are most vulnerable at these locations, which highlights the importance of intersection treatment. Clear visual communication at intersections is important to reduce potential conflict between vehicles, cyclists and pedestrians.

As the character of the street changes from one block to another, intersections provide a transition point from one streetscape type to another. The change in character between blocks underscores the need for consistent design of intersections to ensure they tie the street together and are also easily and safely navigable for all modes of traffic.

Function

- Location for vehicular, cycling and pedestrian traffic to cross or change directions.
- Transition zone between different block streetscape characters and types.
- Space for character, identity and branding of an area.
- Space for gateway identifiers and public art.

As the **streetscape character** of the street blocks change, intersections provide a **transition point** from one streetscape type to another.

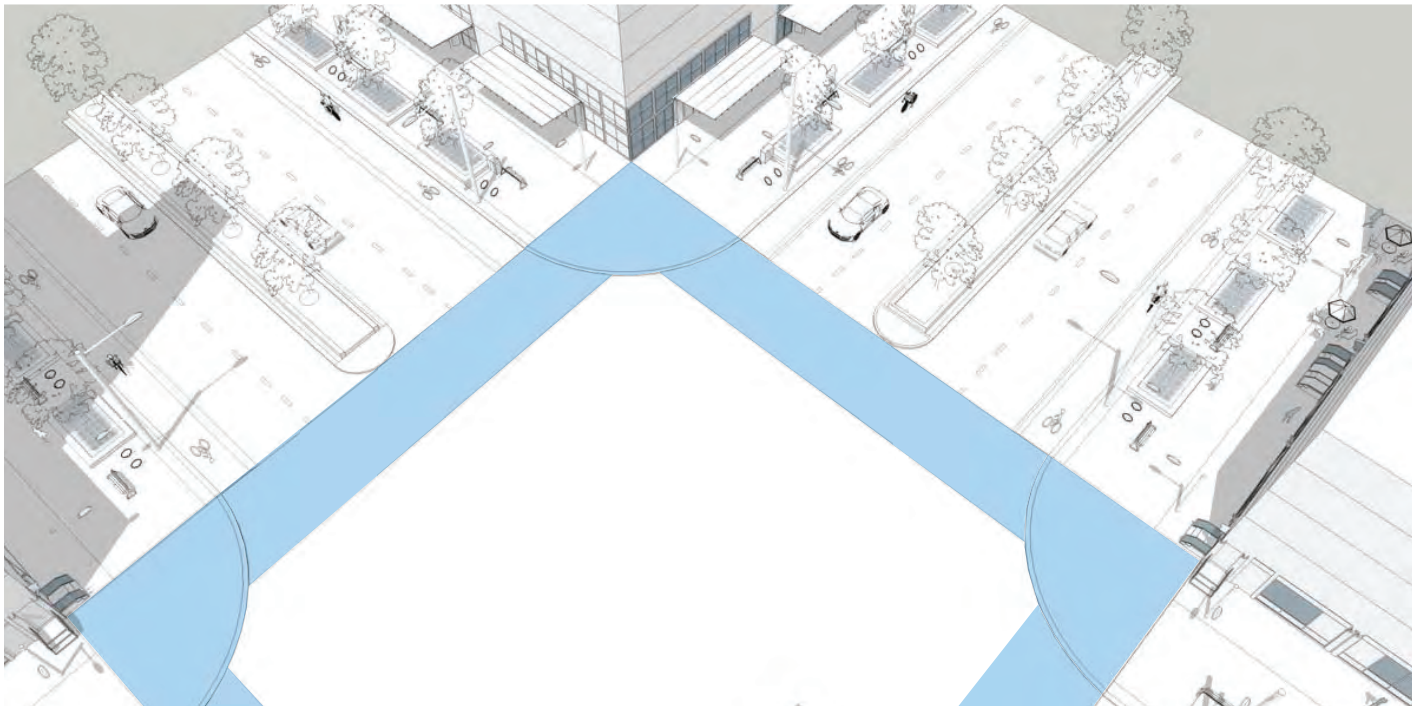

Figure 6.27: Intersections

Structure

When designing intersections four areas need to be considered:

- Mid-block condition
- Transition zone
- Pedestrian corner treatment
- Pedestrian Crosswalk

Mid-Block Condition

Mid-block conditions are the typical conditions of the streetscape where the vehicular roadway and pedestrian boulevard are parallel. Pedestrian and vehicular traffic are separated with generally minimal interaction.



Transition Zones

Transition zones combine with the pedestrian corner treatment to form the intersection in major intersections. Transition zones are located between the mid-block condition and the pedestrian corner treatment. In the transition zone, the rhythm of street trees, paving materials and patterns change in character to signal to pedestrians they are approaching an intersection where more attention is required.

- Transition zones provide notice to pedestrians that an intersection is approaching.
- Rhythm of street trees should decrease in frequency to increase visual sight lines for vehicles and pedestrians approaching the intersection.
- Paving design in the transition zone should be complimentary but differ from mid-block conditions.
- Street furniture at intersections should be located in the transition zone, where appropriate.





Pedestrian Corner Treatment

Pedestrian corner treatments make up the entire intersection in minor intersections, but are combined with a transition zone in major intersections. The pedestrian corner treatment is located at each corner of crossing roadways providing a refuge area for pedestrians to await crossing the roadway to reach the other side. Pedestrian corner treatments are typically treated with hardscape paving materials and make ideal locations for public art and public space. Proposed softscape and planting should promote seasonal interest, xeriscape principles and accommodate winter snow removal operations and storage.

- AODA ramps or drop curbs should be provided at pedestrian crossings.
- Tactile walking surface indicators on curb ramps should be provided to comply with AODA Accessibility Standard for the Design of Public Spaces.

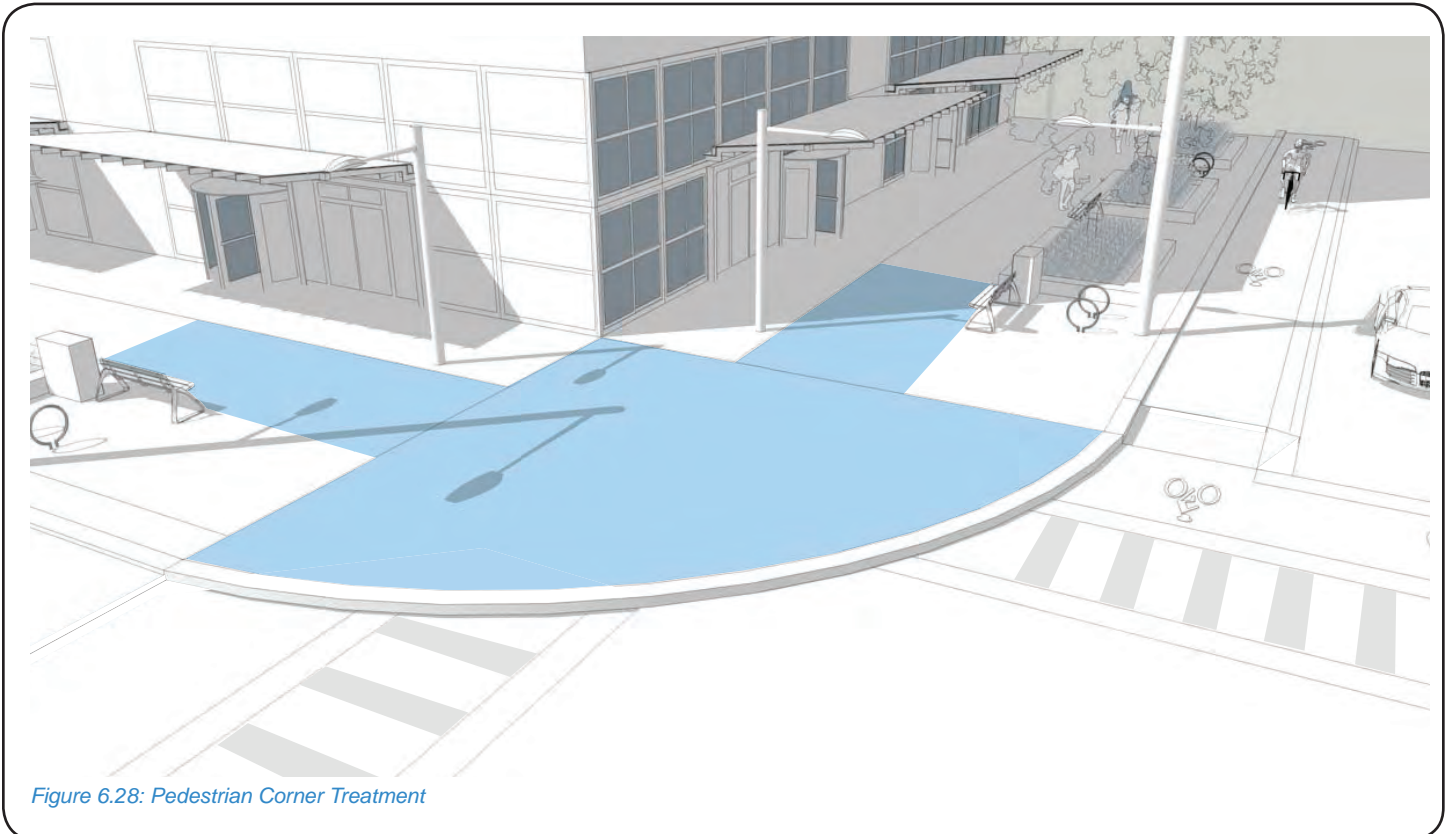

Figure 6.28: Pedestrian Corner Treatment

Pedestrian Crosswalks

Crosswalks are located directly on the vehicular roadway and run perpendicular to the direction of vehicular traffic. The crosswalk is where the pedestrian is most vulnerable. The purpose of the crosswalk is to clearly indicate to both pedestrians and vehicles where pedestrians are allowed to cross the roadway.

- Pedestrian crosswalks must be clearly delineated from the roadway by unique paving or markings.
- Crosswalk treatments should be durable to remain clearly visible to pedestrians and motorists.
- Pedestrian crosswalk markings and treatments should be clear and consistent to avoid pedestrian confusion.
- Pedestrian crosswalks may contain unique markings and colours to reflect the area's identity and branding.
- Raised pedestrian crosswalks should be considered where possible to facilitate accessible and safe crossings.
- When pedestrian crossings are greater than 15 m in length, medians should be considered to provide a pedestrian refuge point.
- Pedestrian crosswalks to be a minimum of 2.5 m wide.
- Pedestrian crosswalks should be positioned 90 degrees from the curb to create the shortest crossing distance.
- Pedestrian crosswalks must be consistent with guidelines in the Ontario Traffic Manuals.

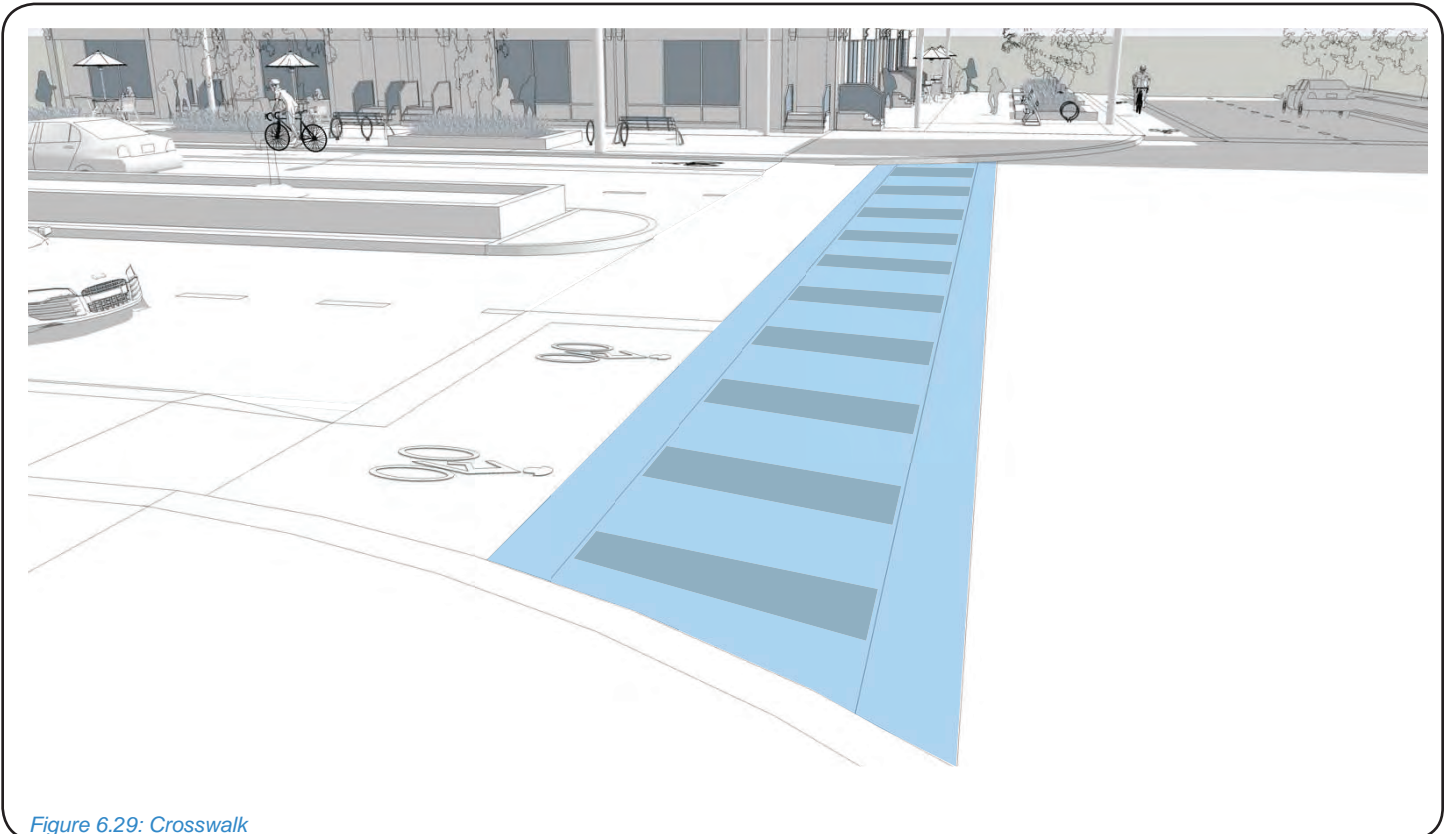

Figure 6.29: Crosswalk

Intersection Types

The delineation between the intersection and mid-block differs based upon the type of intersection. There are two main types of intersections:

- Major intersections
- Minor intersections

Gateway intersections are a sub-type of major intersections.

Major Intersections

Major intersections are typically found in locations where two major roads with high vehicular and / or pedestrian traffic cross. The crossing in major intersections can be of cultural or regional value. The wide right-of-ways and busy vehicular traffic in major intersections create a scale larger than is characteristically comfortable for the pedestrian. A transition zone is added between the mid-block and intersection to mitigate the large scale. Major intersections have a pedestrian corner treatment area of approximately 30 m from curb and a transition zone which varies from approximately 8m to 20 m. This means that the mid-block condition starts from approximately 38 m to 50 m from the intersection curb. It should be noted that VIVA standards call for an approximately 65 m intersection. However, this condition is only effective with large block sizes found in places such as Highway 7.

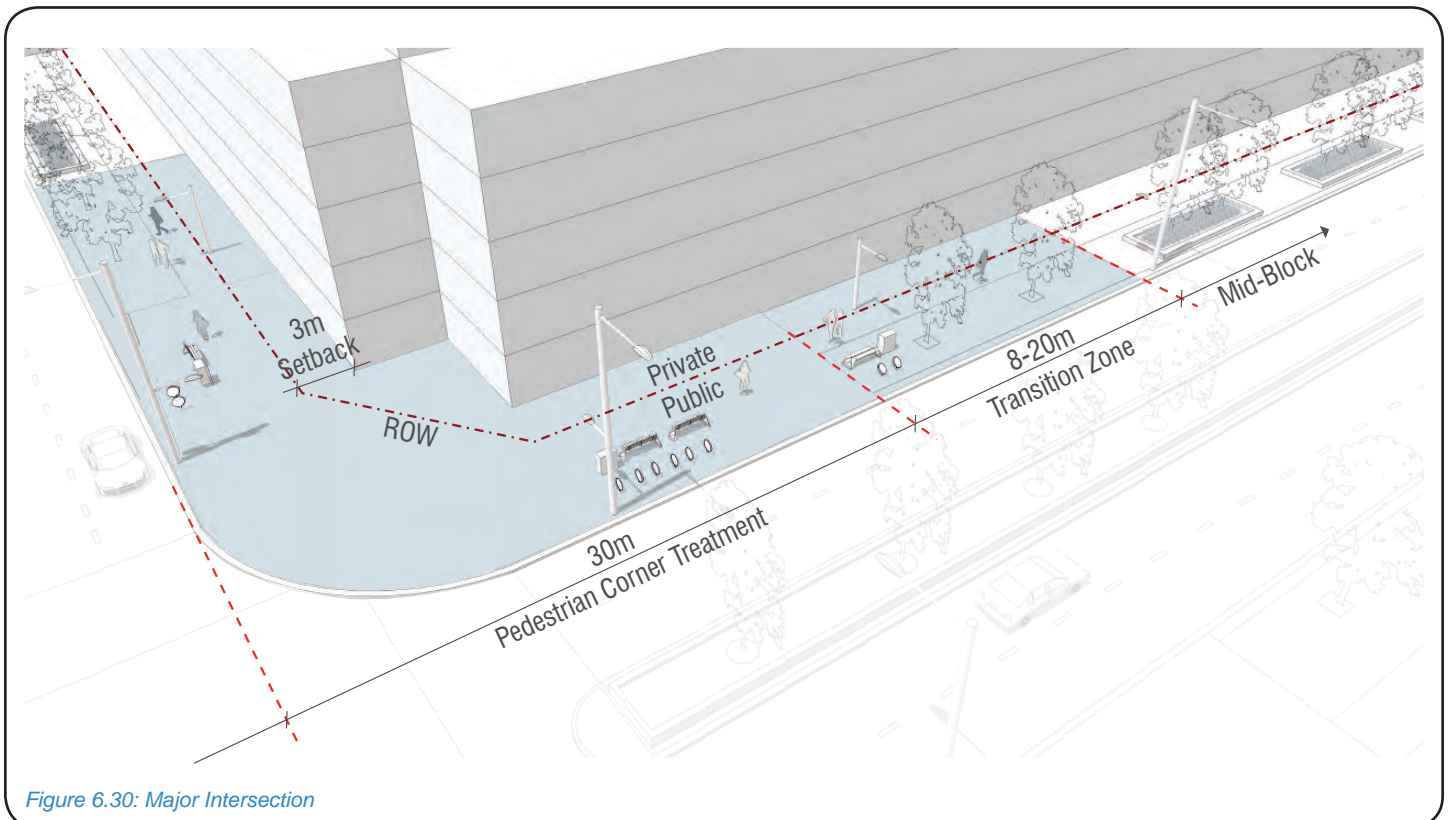

Figure 6.30: Major Intersection

Gateway Intersections

Gateway intersections share the same structural framework as major intersections within the ROW. Gateway intersections differ from major intersections by having specific branding elements in the streetscape including character district branded pavers, branded banners on street poles and branded street furniture. Buildings located at gateway intersections should provide space for a public / private zone within the private setback zone which could include public art and other public activities.

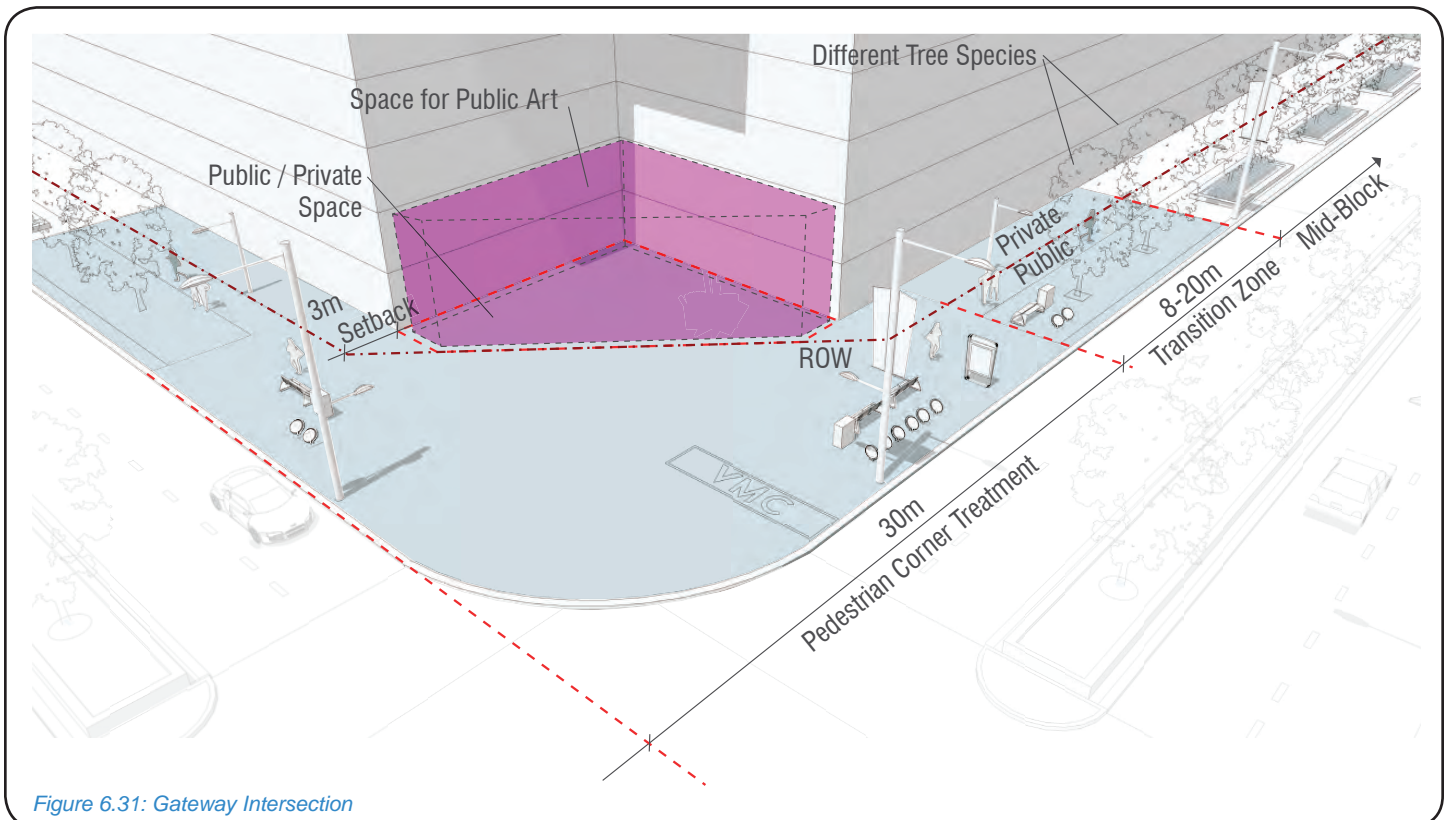

Figure 6.31: Gateway Intersection

Minor Intersections

Minor intersections are smaller in scale than major intersections but still can have a high volume of pedestrian traffic. They do not typically have the high vehicular volumes of major intersections and are more comfortable for the pedestrian scale. There is no transition zone needed in minor intersections with this smaller scale. The pedestrian corner treatment of minor intersections measure approximately 10 m from the curb to mid-block condition depending on context.

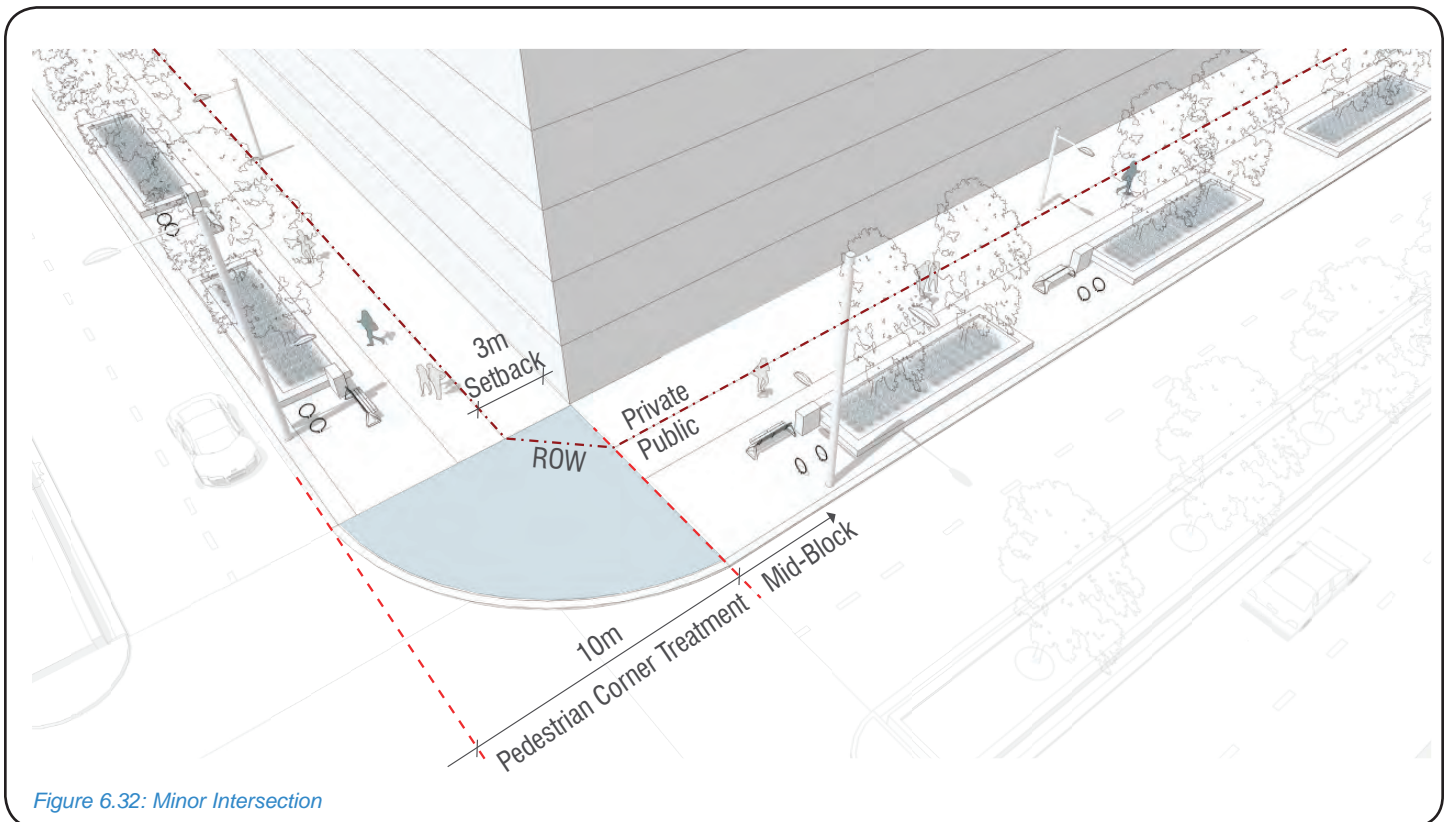

Figure 6.32: Minor Intersection

Other Intersection Considerations

Curb Extensions

- Curb extensions, or “bump outs” provide passive traffic calming, define space for on-street parking and public transit boarding, and reduce pedestrian crosswalk distances.
- The use of curb extensions is encouraged where appropriate on streets with on-street parking.
- Consider curb extensions as potential areas for planting, special paving and fire hydrants.

Cycling Facilities at Intersections

- Cycling facilities at intersections allow for greater safety between competing modes of transportation (motor vehicles, cyclists and pedestrians).
- When bike boxes are used in the roadway, they should be clearly defined in such a way as to be visually unique from the pedestrian crosswalk and located behind the pedestrian crosswalk.
- Bike lane line markings / patterns should not extend through pedestrian crosswalks with the exception of dashed lines in complex intersections.

Sight Triangles

- Sight triangles should provide clear visibility between all modes of transportation in the intersection to ensure safety from collisions.
- The sight triangle should be clear of obstacles which may block a vehicles view of pedestrians, cyclists and other vehicles traveling into the intersection.
- Sight triangles should be lit to ensure clear vision during the night time.
- On-street parking should be set back from the crosswalk to ensure clear sight lines.
- Shrubs and plants should be no higher than 0.8 m in height at maturity within sight triangles.
- Street furniture, if located in the sight triangle, should be no higher than 0.8 m in height.
- Trees should not be closer than 9 m from the intersecting curb face.
- If the tree canopy encroaches into the sight triangle, it should maintain a minimum clear vertical clearance of 1.85 m from the ground.
- Street furniture, paving, small trees and shrub planting should be included in site triangles to ensure the continuation of the streetscape character provided that they follow site triangle design guidelines.
- Designers and developers should work with the Region and City to minimize site triangles.

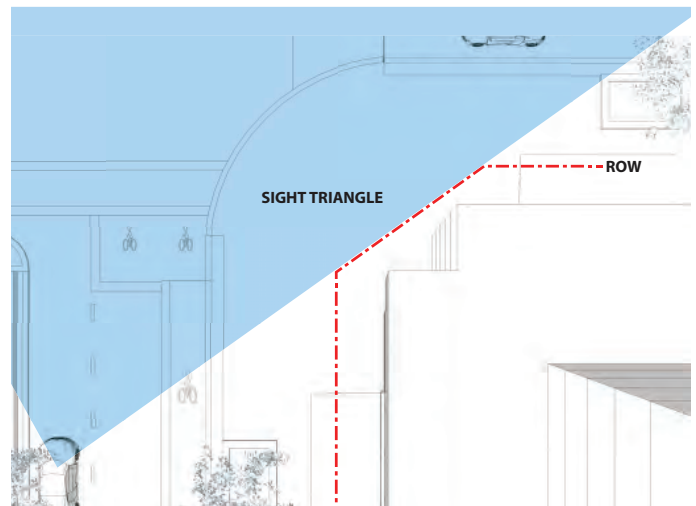
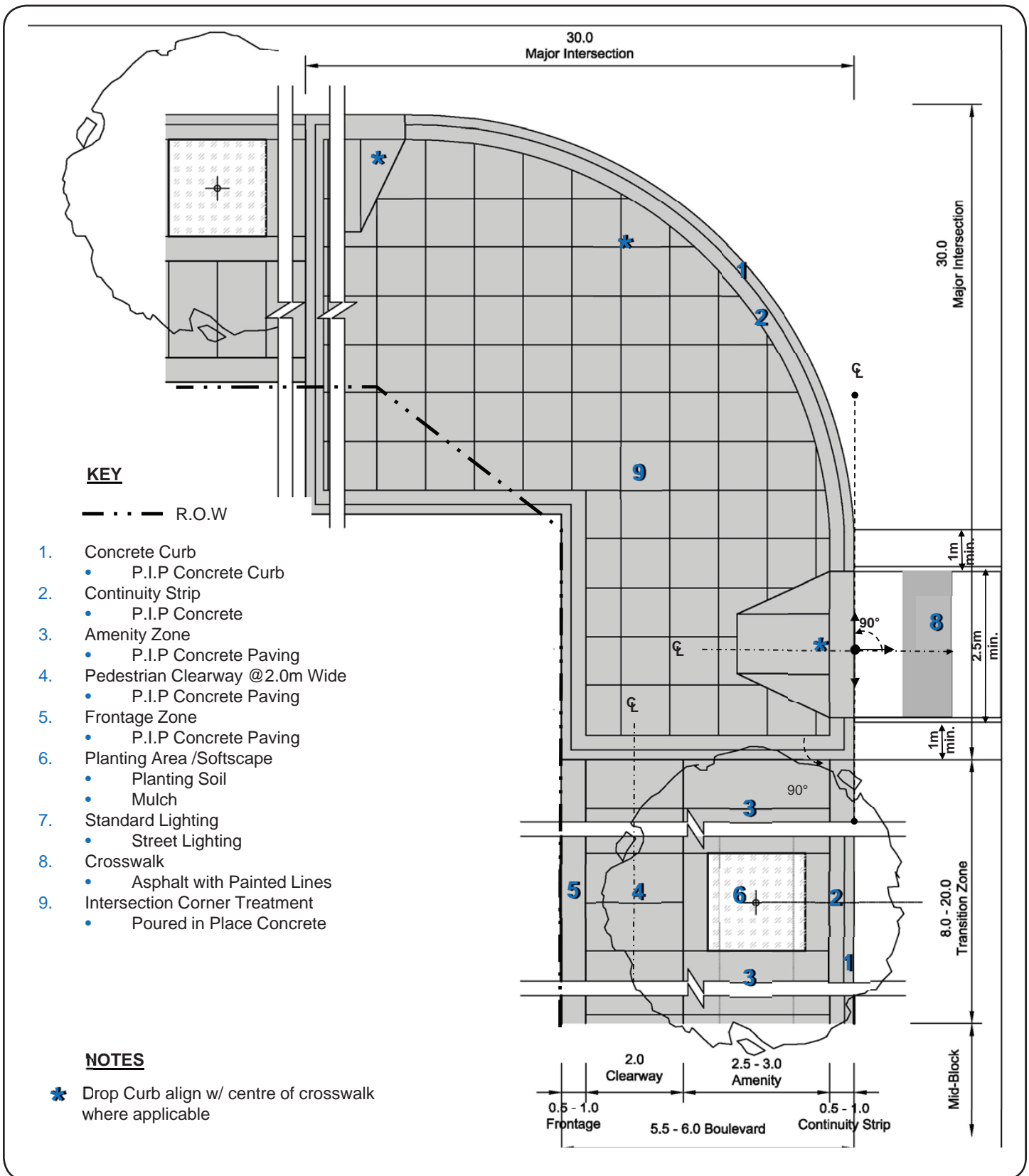
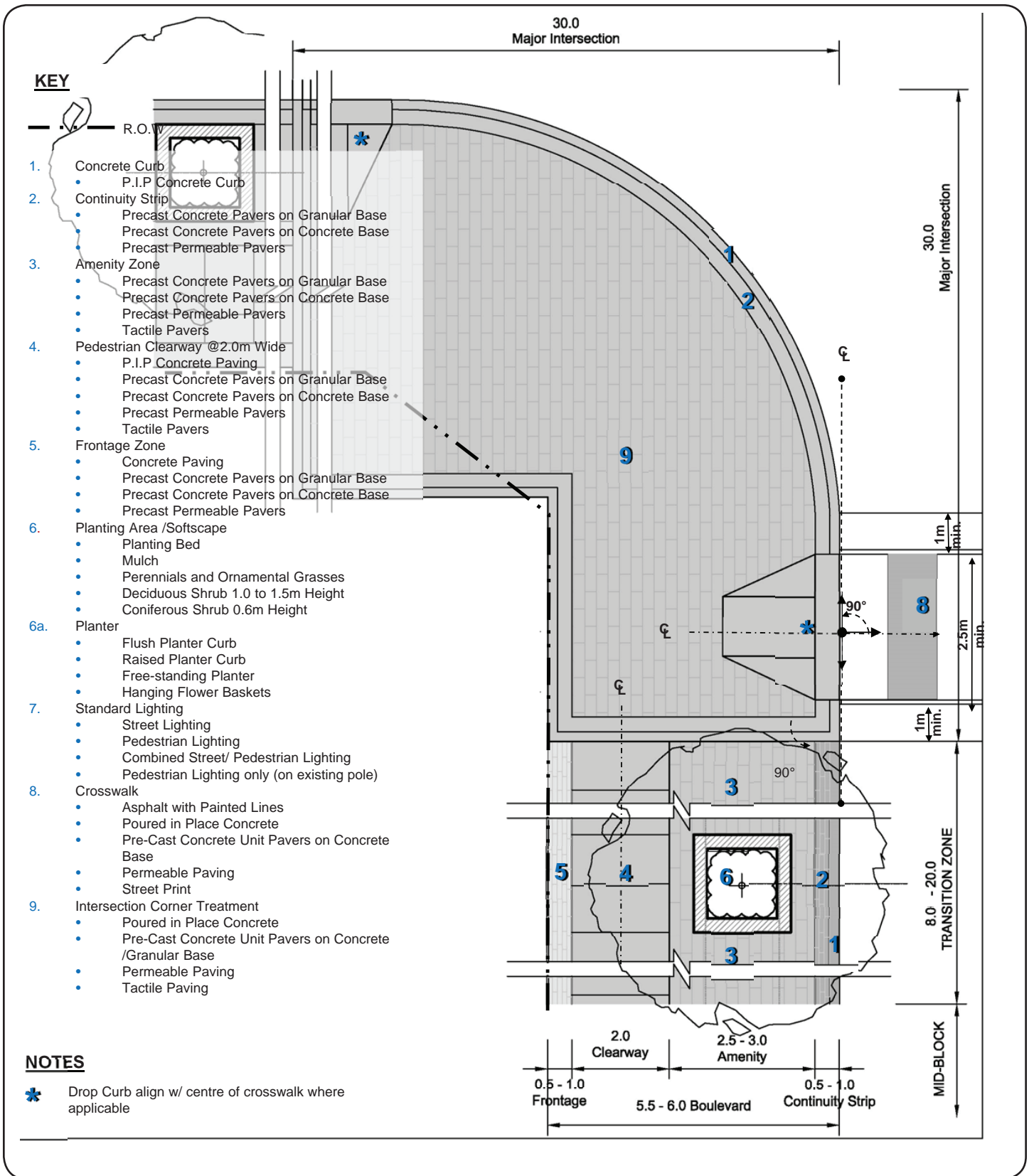

Figure 6.33: Sight Triangle

Standard Urban Major Intersection



Enhanced Major Intersection



Premium Major Intersection

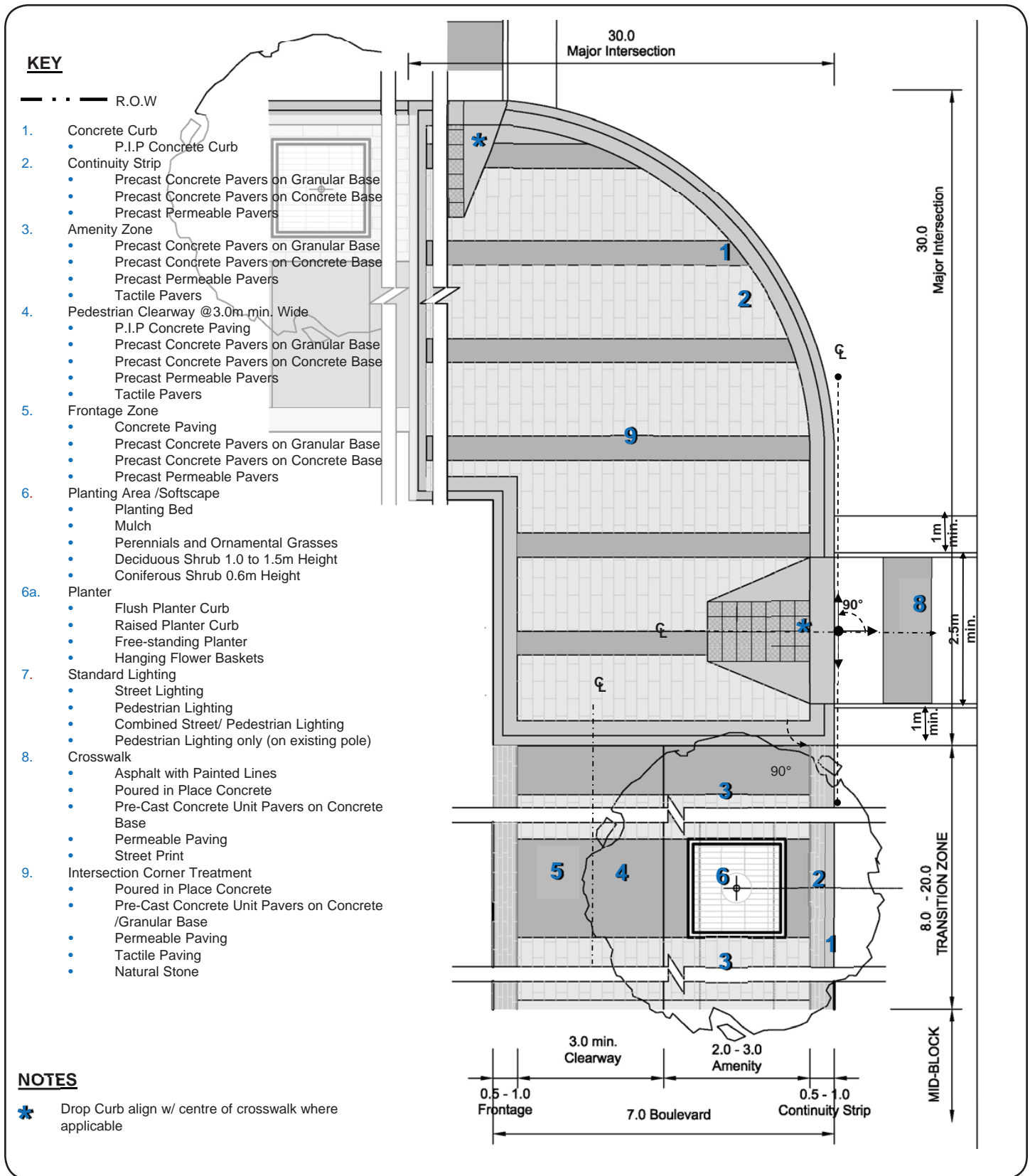

Standard Urban Minor Intersection

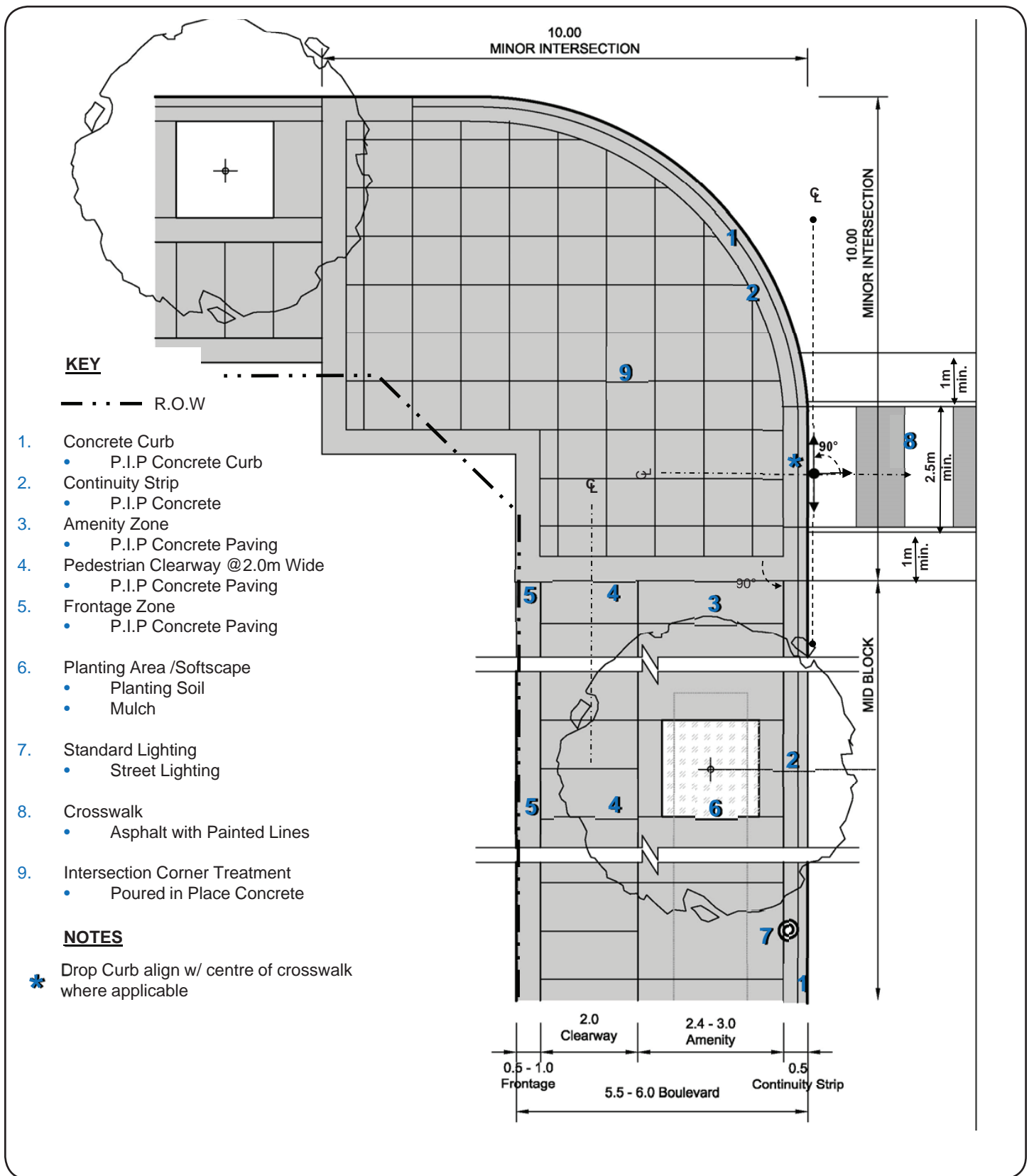

Enhanced Minor Intersection

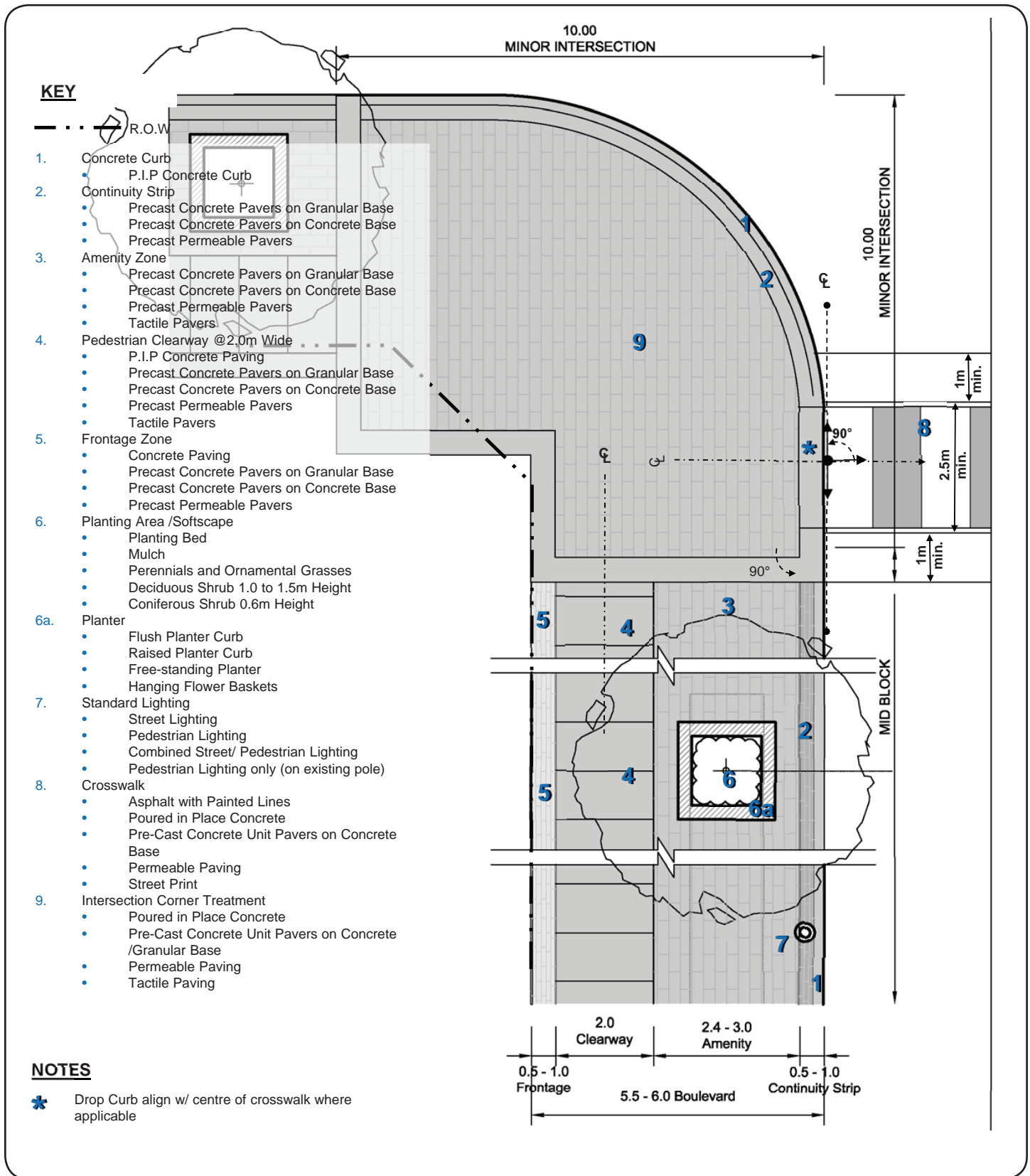

Premium Minor Intersection

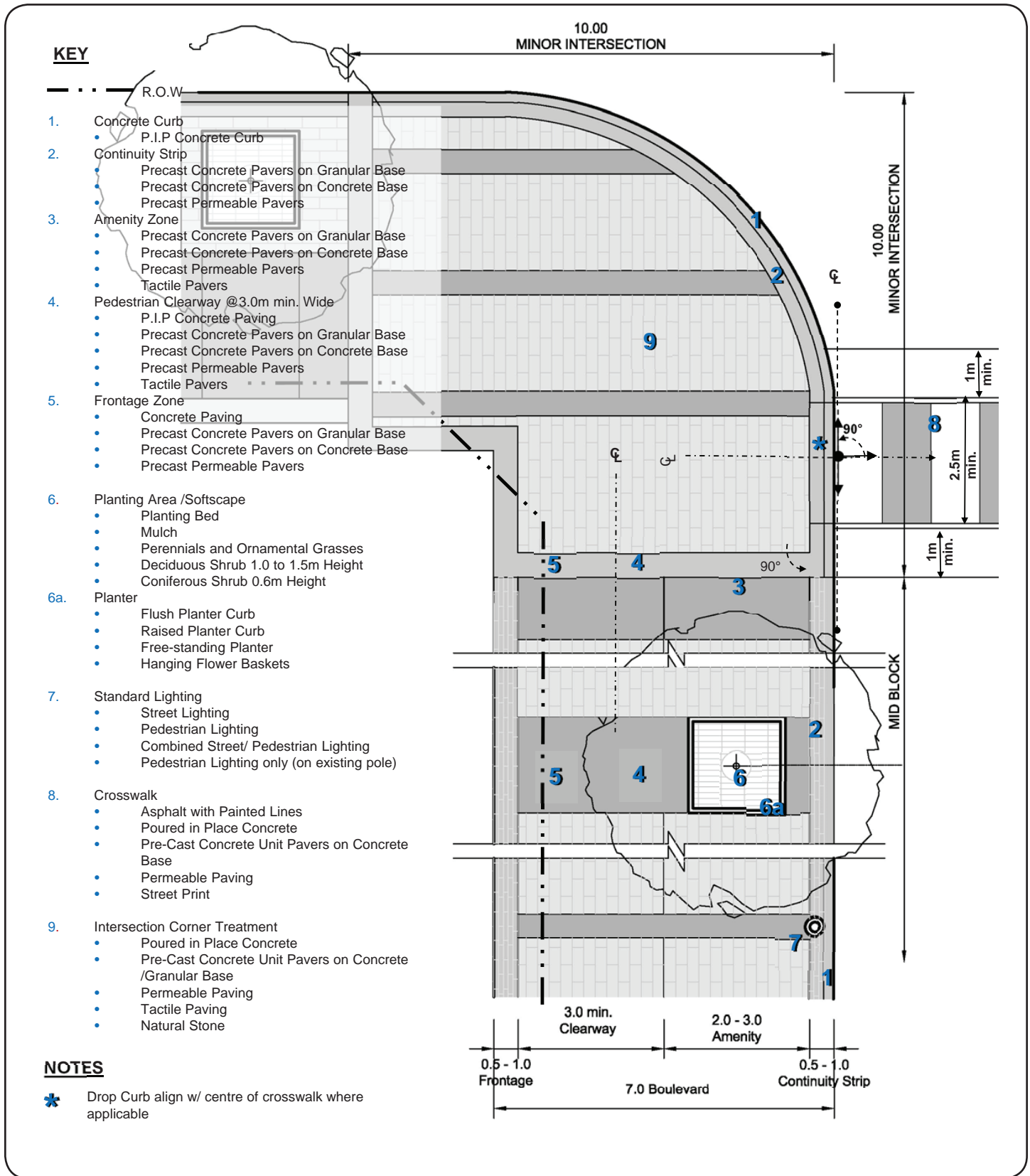

Public / Private Frontage

Adjacent to the frontage zone, between the right-of-way and the building face is the private frontage zone. While this is outside of the public boulevard, the treatment of the zone is important to consider as it influences pedestrian interaction with adjacent buildings and the character of the street. The importance and design of the private frontage changes according to the adjacent land-use and streetscape type.

Typically, this zone is used for building entrances, outdoor cafes, retail display areas, landscaping feature lighting and public art.

Two functions typically determine how the public / private frontage is treated:

- Activity
- Semi-private

Activity

The public private frontage area can be used as an activity space for high volume pedestrian traffic and interaction between the public and private realm. Potential uses for public / private frontage activity areas include:

- Entrances to buildings
- Outdoor cafes and seating
- Information kiosks and displays
- Landscaping and planters
- Public art
- Retail displays

General treatments include:

- Paving should be continuous and / or complimentary to the paving located in the adjacent pedestrian boulevard.
- Paving may be used to provide definition between public and private space to aid maintenance activities.
- Canopies may be permitted above the public / private frontage.

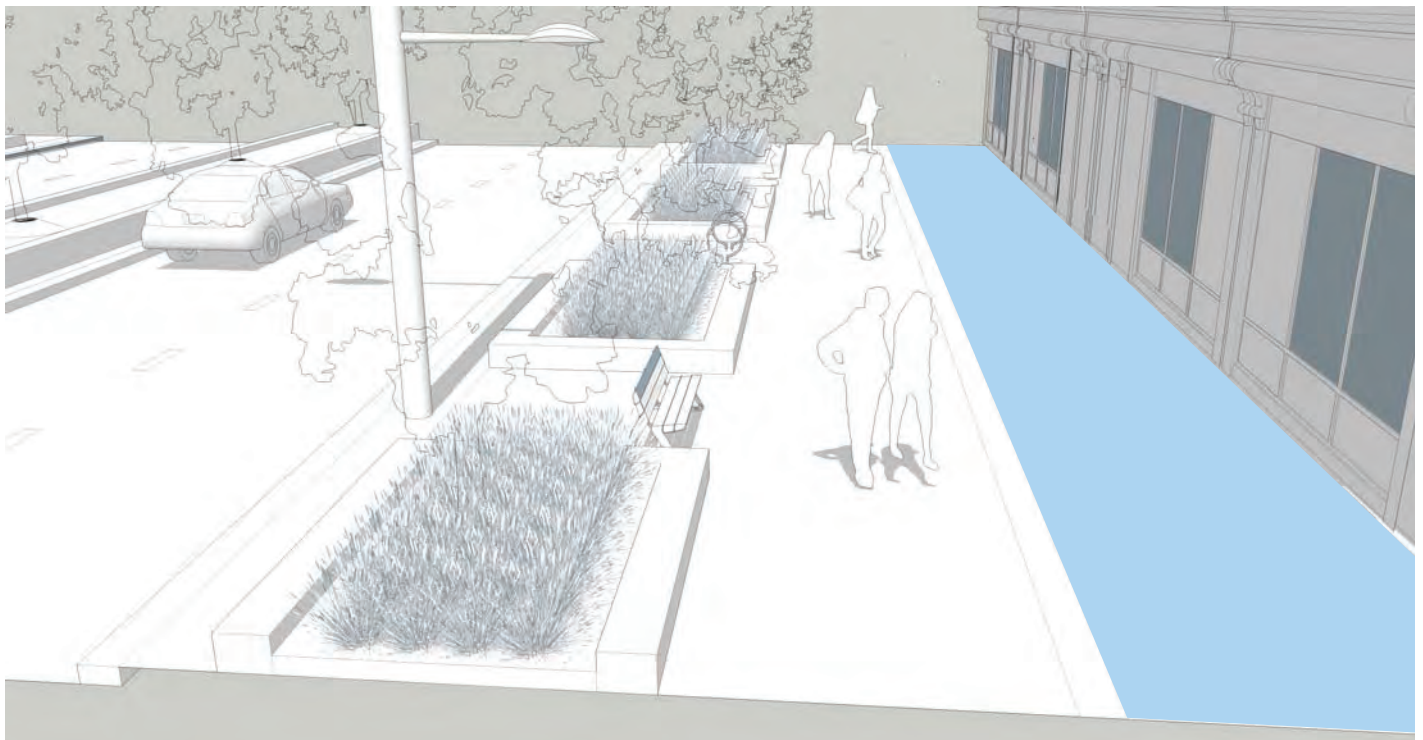

Figure 6.34: Public / Private Frontage

- Where public art is planned, canopy / public art coordination between architect and artist is required.
- Temporary / movable landscape displays / planters.
- Where night time activities are present, such as cafes, restaurants, shopping and entertainment, provide supplementary lighting for safety and security.
- Emphasize consolidated building entrances with creative landscaping, including movable planters, and lighting.
- Where appropriate, provide additional seating to accommodate private land uses such as retail, commercial, cafes and around public art.

Semi-Private

Semi-private functions of the public private frontage act as semi-visual and semi-physical barriers between public and private areas. The zone acts as a transition zone and provides a measure of privacy and screening. Potential uses for public / private frontage semi-private areas include:

- Private residential entrances
- Private residential yards
- Landscaping

General treatments include:

- Vegetative screening treatments shall include barrier vegetation such as small trees, shrubs, perennials and ornamental grasses.
- Physical barriers including yards, planters, stairs, gates and fences.



Utilities

Natural gas, electrical, telecommunications, water, sewer and transit related services combine to create a complex network of public utilities both above and below ground. Above ground public utilities physically and visually congest the streetscape and take away valuable amenity space. Below ground public utilities must be coordinated with tree planting.

Intensification areas will host greater population density than currently exists in Vaughan. The additional density will place a greater demand for space in the right-of-way for pedestrians, cyclists and vehicular traffic and greater demand and stress on the public utility network from adjacent land uses. The public utility network will need to add additional capacity to accommodate development which will require more space in the streetscape. In the interest of high quality urban pedestrian environments, it is recommended that public utilities be located underground.



Street with Overhead Hydro Wires



Street without Overhead Hydro Wires (Preferred)

Municipal Standards

Municipal standards are applied to municipal streets such as minor arterials, major collectors, minor collectors, special collectors, local roads and mews. The Vaughan Engineering Standards indicates the use of a single utility corridor for public utilities. The shared utility corridor is ideal to minimize conflicts with street tree roots found in the amenity / planting zone. However, the stacking nature of the public utilities can potentially create service interruptions to access and maintain unrelated services below. It is recommended that hydroelectricity on municipal roads be buried below ground in Intensification Areas and Heritage Conservation Districts as opposed to above ground power poles which take space in the amenity zone and are not proportionate with the human scale. Underground utility placement should be coordinated with street trees and street lights early in the project process to limit conflicts. It is important to note that street trees are considered of equal importance as utilities. Coordination should refer to the Vaughan Engineering Standards.

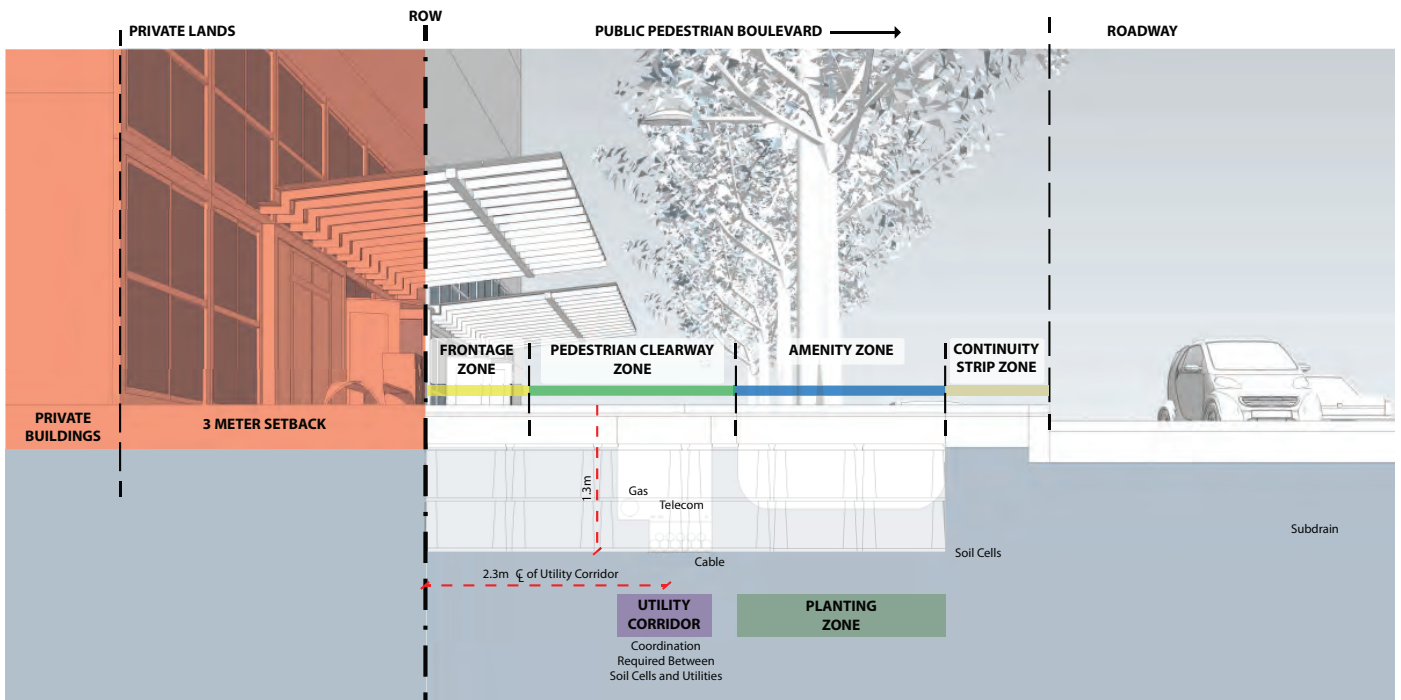

Figure 6.35: Vaughan Municipal Utility Placement Standard

Raised Cycle Tracks

Where raised cycle tracks are within the pedestrian boulevard, the raised cycle track shall be non-encumbered, having no public services located below the cycle track where feasible. Coordination should refer to the Vaughan Engineering Standards.

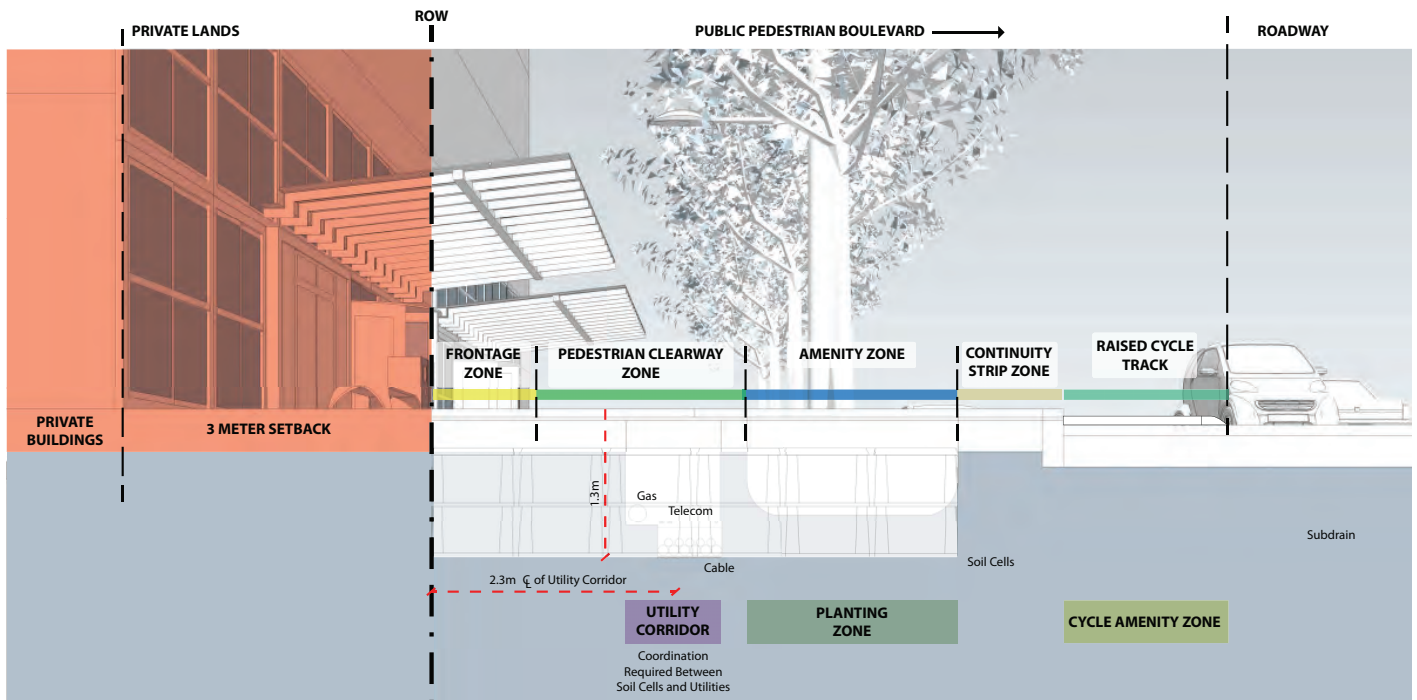

Figure 6.36: Raised Cycle Tracks in the Boulevard should be Unencumbered

Public Utility Considerations

SERVICES

Electrical Power

While it is preferred that electric power lines be located below grade, the reality is that they may be located above ground on regional roads in intensification areas on an interim basis. Typically, electric power poles stand approximately 24 m – 27 m in height and are located approximately 1.0 – 1.5 m from the curb line in the amenity zone. Electrical lines should be located as high as possible to minimize their visual impact.

Agreements on connections for power to private development will be made with private land owners and may be overhead or below ground depending on the scale of the development.

Gas

Natural gas mains are the public utility typically located nearest to private property. Under the municipal standards, the gas main should be located in the utility corridor which may cross underneath the frontage zone or pedestrian clearway zone. For ease of maintenance, this location is ideal.

Communications

Communication public utilities include telecom and CATV. Owned by private companies, there are various providers with different requirements. These public utilities are typically found under the pedestrian boulevard within a utility corridor for ease of maintenance access. Access hatches and man holes will be required periodically for maintenance.

Water

Where water services are located under the pedestrian boulevard, care must be taken to ensure they are located under the continuity strip zone to avoid conflict and damage from street tree roots in the amenity zone / planting zone. In cases where a raised cycle track is provided as part of the boulevard, water services shall not be placed below the raised cycle track.

Sanitary and storm sewers are typically located under the vehicular roadway and measured from the road centre line according to municipal standards.

Transformers

Transformers shall be located on private lands by means of an enclosed electrical service room as part of future building development or as a separate transformer building / walled compound. Convenient access for maintenance by electrical services staff is to be provided. Transformer housings should be designed in a consistent manner to the architectural character of the development. Alternatively, high quality visual screening in the form of walls, metal screens or other approved screening devices may be used.



ADDITIONAL CONSIDERATIONS

Operations and Maintenance

There are occasions where the operations and maintenance of public utility infrastructure require the pedestrian boulevard to be excavated for access. Locating the utilities in a consistent manner relative to the streetscape zones allows for smaller areas of excavation and thus reduced maintenance costs. Consistent locations also reduce the dangers of damage to different utilities and unforeseen complications.

During excavation to access the public utility infrastructure, surface and paving materials are removed from the pedestrian boulevard. In some cases, the excavation means that the surface or paving materials require replacement. The use of unit paving materials minimizes replacement costs during public utility maintenance. The original boulevard unit paving can be removed and properly reinstalled to maintain the character while reducing the cost of replacement. Poured in place concrete must be broken leading to new concrete being poured to fix the surface treatment.

Operations and maintenance of public utility infrastructure can also cause disruption in the streetscape. When public utilities are located below the frontage and pedestrian clearway zone, maintenance requires the area to be hoarded off for pedestrian safety. This leads to disruption of pedestrian traffic and business operations of adjacent land uses. Careful utility coordination and communication with adjacent land owners helps to minimize the impact of the disruptions.

Street Trees

The unpredictable nature of tree root growth gives rise to concern of conflicts between street tree roots and below grade public utilities. Street tree roots can potentially damage public utility infrastructure and make it harder to access public utilities if the roots wrap around the services. On the other hand, public utilities can interfere with street tree root growth and cause a deterioration of tree health. Public utilities below grade must be located away from the amenity zone, and in particular, away from the planting zone below trees to minimize these conflicts. Street trees are considered a streetscape infrastructure element of equal importance to utilities and should therefore be coordinated early in the planning process with utilities and illumination elements.

Strata Parking

Careful coordination between public utilities and strata parking agreements must be undertaken in order to minimize conflicts. For example, acceptable space between below grade public utilities and strata parking structures must be ensured in addition to adequate depths for public utilities below the surface. Careful design must also be considered where public water services are near strata parking structures in the event of pipe malfunction.

Organization and Coordination

It is recommended that organization and coordination of public utilities and services be coordinated formally in the future by a Public Utilities Coordinating Committee (PUCC). The greater demands and population density in Vaughan will require a higher complexity of public utilities. A committee will be able to map, regulate and coordinate the growing development of public utilities to ensure timely service.

Innovation

The intention of innovation components is to encourage innovative development of streetscapes. Innovation components can be pilot projects to test new streetscape infrastructure including low impact development measures. Typically found in the amenity zone, but not limited to it, innovation components are meant to contribute to a memorable pedestrian experience or demonstrate leadership in technical solutions and/or triple bottom line sustainability. Innovation components may be cultural inspirations and contribute to neighbourhood character. Innovation components also represent ideal situations for educational activities and interpretive signage.

Due to the unique nature of innovation components, special design considerations and coordination is required to ensure successful implementation on the streetscape.

Potential innovation components include:

- Low impact development measures
- Public art
- Digital media and communication installations
- Flexible street design with rolled curbs
- Planting strategies
- Temporary landscape installations



Low Impact Development Measures

Philosophy and Approach

Low impact development (LID) measures can form part of the streetscape infrastructure while providing multiple benefits to pedestrians and the environment including mitigation of the urban heat island effect, reduction of energy demands, reduction of stormwater flows, protection from flooding, sequestration of carbon, filtration of air and water pollutants as well as a range of aesthetic improvements, pedestrian comfort, social, community and economic benefits. By incorporating LID measures into the streetscape, the streetscape becomes a natural element in the local ecology and reduces the impact its development has on the natural environment.

Incorporated into the Design

LID measures should be incorporated into the streetscape design early in the design process. For this reason several typical LID measures have been included into the streetscape component list. However, it is recognized that LID technologies and innovations are constantly evolving. LID measures have varying degrees of inter-connectivity with adjacent buildings, land uses and public services, etc. Therefore it is important to remain flexible and adaptable when designing a street that includes LID measures. Designers are encouraged to not only consider storm water management in the traditional sense but also in conjunction with other sustainability objectives.

Live Work Play

The Vaughan City-Wide Streetscape Implementation Manual encourages the live, work, play concept. While normally applied to neighbourhoods, the streetscape is an important part of the live, work, play philosophy. Streetscapes are large networks of public space and should be treated as extensions of residential, retail, commercial and recreational land uses. Streetscapes should encourage individuals to walk and lead healthy and active lifestyles and therefore must cater to pedestrian needs.

The Vaughan City-Wide Streetscape Implementation Manual also encourages the use of other criteria and performance measures which affect the design of streetscapes and low impact development including:

- Sustainable Sites Initiative
- LEED for Neighbourhood Development

The following criteria and performance measures should be considered in conjunction with low impact development measures for streetscape design.



Sustainable Sites Initiative (SITES)

It is important to encourage the collaboration of natural and built systems to improve the long-term health of the environment and of socially and economically viable communities. The American Society of Landscape Architects Sustainable Sites Initiative (2009) has established criteria, which is intended to compliment the U.S. Green Building Council's LEED-ND Rating System, to facilitate such collaboration. It is the intent of the criteria to help transform traditional land development and management practises toward more sustainable methods. The criteria are as follows:

Site Selection Considerations

- Protection of floodplains by restricting development from the 100-year floodplain of waterways
- Restricting development from wetland areas
- Protection of habitats belonging to threatened or endangered species
- Brownfield or greyfield redevelopment as opposed to greenfield development
- Reduce pollution and improving human health by designing accessible sites for pedestrians, cyclists and locating near public transit

Pre-Design Assessment and Planning Considerations

- Site assessment to explore site sustainability opportunities
- Integrated site development process
- Meaningful public engagement process to inform site design

Water Considerations

- Reduction of potable water, natural surface water and groundwater for landscape irrigation after plant establishment
- Use of water conservation strategies and other irrigation methods
- Protect and restore riparian, wetland and shoreline buffers
- Restoration and maintenance of site water balance
- Integration of rainwater / storm water features into the site design which provide aesthetic and physical amenities while providing water management functions

- Conservation of water by designing and maintaining water features integrated into the landscape with minimal or no make-up water from potable sources or other natural surface or subsurface water resources

Soil and Vegetation Considerations

- Implementation of management plans to control known invasive plants found on site to limit their damage to local ecosystems
- Improve landscape performance and reduce resource use by using appropriate plants such as non-invasive species
- Use of appropriate vegetation native to the site eco-region
- Preservation and restoration of native plant communities
- Define location and boundaries of vegetation and soil protection zones through the use of a soil management plan prior to construction to limit disturbance and assist in soil restoration efforts.
- Preservation and identification of special status designated vegetation by local, provincial and federal governments
- Restoration and preservation of appropriate plant biomass on site
- Reduce building heating and cooling requirements by strategically planting vegetation around buildings
- Reduction of the heat island effect by use of vegetation and reflective materials

Human Health and Well-Being Considerations

- Promotion of equitable site development and use
- Influence of habitual user behavior through education and interpretation of on-site sustainability features and processes
- Enhance a sense of place and meaning by protecting unique cultural and historical features
- Design for safety, ease of wayfinding and full accessibility
- Provide amenity space to accommodate physical activity to promote active and healthy lifestyles
- Incorporate space for quiet mental restoration with views to vegetation and calming features
- Provide community building and social amenity

space through gathering spaces of various sizes and orientations

- Minimize light pollution by reducing sky-glow, increasing nighttime visibility and minimize negative effects on nocturnal environments and human health and functioning

Materials Selection Considerations

- Preserve threatened tree species by using alternative wood species
- Conservation of resources and avoid landfill waste by using salvaged materials and plants
- Support socially and environmentally responsible forest management by using certified wood
- Use locally sourced materials, plants and soils
- Reduce air pollution through the use of low VOC (volatile organic compounds) paints, sealants, adhesives and coatings
- Support manufacturers using sustainable practices in plant production and material manufacturing

Construction Considerations

- Protection of water, air quality and public safety by preventing or minimizing the discharge of construction site pollutants and materials
- Use of disturbed soils during construction in areas to be re-vegetated
- Divert construction and demolition materials bound for disposal in landfills from site development to recycling whenever possible
- Manage construction and design to achieve a net-zero waste site by reusing and recycling vegetation, rocks and soil generated during construction
- Limit greenhouse gas emission and air pollutant generation during construction

Operations and Maintenance Considerations

- Achieve maintenance goals with a site maintenance plan through long-term strategies and short term actions
- Facilitate recycling and reduce water generation by providing storage and collection space for recyclables
- Organic matter from site operations and maintenance to be recycled

- Minimize outdoor energy consumption for landscape and exterior operations
- Reduce greenhouse gas emissions and minimize air pollution by using renewable sources for landscape electricity needs
- Minimize greenhouse gas emissions and exposure to localized air pollutants from landscape maintenance activities
- Provisions for preferred parking for reduced emissions, high-fuel efficiency and / or carpools to reduce emissions

Monitoring and Innovation Considerations

- Improve the body of knowledge of long-term site sustainability by monitoring and documenting sustainable design practices and evaluate their performance over time
- Reward innovative sustainable practices which exhibit exceptional performance in all aspects of site design



LEED for Neighbourhood Development

Working in conjunction with the Sustainable Sites Initiative (SITES), it is important to consider criteria found in the LEED 2009 for Neighbourhood Development (LEED-ND). The LEED-ND places a strong emphasis on site selection, design and construction elements to integrate building and infrastructure design together. While the rating system of LEED-ND is generally applied to new neighbourhoods, the criteria are still useful as a tool to set the performance levels of streetscape infrastructure.

Therefore, adapted from the U.S. Green Building Council's LEED 2009 for Neighborhood Development Rating System, updated May 2011, the following performance criteria is intended to guide healthy, durable, affordable and environmentally sound practices for streetscape design. The criteria are as follows:

Smart Location and Linkage

- Promote active transit, public transit usage and reduce personal vehicular trips to improve and redevelop existing communities
- Use locations with multi-modal choices to promote development and reduce personal vehicular usage, reduce greenhouse gas emissions and air pollution
- Provide bicycle infrastructure such as a bicycle network, bike parking and storage to promote utilitarian active transportation habits and support the public health benefits
- Support the live, work, play concept by encouraging a diversity of uses for balanced communities
- Protect and restore native plants, wildlife habitat, wetlands and water bodies

Neighbourhood Pattern and Design

- Provide safe, appealing and comfortable streetscape environments to support public health and safety through encouraging daily physical activity
- By prescribing compact development, promote livability, walkability and transportation efficiency
- Promote the development of communities with a high degree of internal connectivity
- Create walkable streetscapes which have buildings and activities close to the street, limit building facades which do not have activation or are blank along the streetscape, ensure ground level retail is visible at night, provide on-street parking, limit driveway entrances through the streetscape and promote continuous sidewalks on both sides of the street
- Facilitate walking, cycling and public transit use by clustering diverse land uses in mixed-use accessible neighbourhood centres
- Design for a diversity of housing types, affordable housing options and mixed-income communities to promote socially equitable and engaging communities
- Minimize the environmental effects of parking facilities by moving off street surface parking to the rear or side of buildings to increase the amount of building and streetscape connection.
- Promote active transit and public transit use with safe, convenient and comfortable transit waiting areas, and secure bicycle storage facilities
- Provide easily accessible public open space near employment and residential land uses to improve social capacity, physical and mental health
- Improve physical activity and social networking through the provision of a variety of recreational facilities close to employment and residential land uses
- Enhance accessibility with the universal design of all streetscape elements
- Promote health and nutrition with access to community-based food production and local farmer support
- Reduce the heat island effect and improved air quality by providing tree lined streets with shade which encourages walking, cycling and public transit use

Green Infrastructure and Building

- Promote the use of green building practices in design and construction of streetscapes
- Design and construct innovated streetscapes which reduce air, water and land pollution and adverse environmental effects from energy production and consumption
- Reduce dependency on the community fresh water supply and wastewater systems with streetscape infrastructure which deals with storm and building water efficiency
- Reduce construction activity pollution by controlling soil erosion, waterway sedimentation and airborne dust generation
- Limit or eliminate the use of potable water and other natural surface or subsurface water resources for landscape irrigation
- Preserve historic resources and cultural landscapes in a manner that preserves historic materials and character-defining features.
- Preserve existing non-invasive trees, native plants and pervious surfaces.
- Retain stormwater on site, through infiltration, evapotranspiration and / or reuse.
- By using materials with a Solar Reflectance Index (SRI) of at least 29, pervious pavement (at least 50%) and designing a street tree canopy reduce the heat island effect of the streetscape
- Encourage on-site renewable energy production to reduce adverse environmental and economic impacts associated with fossil fuel production and use.
- Design for energy efficient infrastructure to reduce energy consumption with traffic lights, streetlights etc.
- Design infrastructure elements with recycled and reclaimed materials (roadways, parking lots, sidewalks, unit paving etc.)
- Minimize light pollution by reducing sky-glow, increasing nighttime visibility and minimize negative effects on nocturnal environments and human health and functioning

Innovation and Design Process

- Foster continued innovation and exemplary performance in green building, smart growth and new urbanism that is not found in the LEED for Neighbourhood Development Rating System.
- Promote strategies to address issues of social equity, public health and geographically specific environments



Public Art

Public art enriches the experience of the public realm providing visual and tactile stimulation. Given that public art pieces are unique, they are often used as way-finding structures and contribute to the unique character of the neighbourhood.

The inclusion of public art within the right-of-way of public streets presents numerous technical challenges. The right-of-way zone contains many below grade and above grade services, requiring unobstructed access for repairs and maintenance, unobstructed access for snow removal services, subject to restrictions for sight lines of vehicles and available space within the right-of-way.

For constrained right-of-ways, alternative public art options include murals, light projections, architectural facades and building facade shrouds typically used as hoarding during construction.

The following discussion of potential opportunities is intended as a means of implementing public art into streetscapes in recognition of these technical requirements.



Public Art on Public Land



Public Art on Private Land

Opportunities

Public Spaces

In light of the restrictions of locating public art in the public right-of-way, focus should be placed on the most publicly accessible areas of the streetscape as well as on adjacent public spaces such as roadway and pedestrian route intersections within the designated “amenity zone”.

Where possible, public art should be included within and adjacent to public transit stops, especially at highly visible intersections. As well, where possible, public artworks projects should be scheduled to coincide with planned capital improvement and repair projects such that efficiencies in funding, through leveraging of total capital budgets, can be recognized. Artwork budgets should be applied to existing budgets for design elements such that the “delta” of the art budget can be maximized.

Ideally, artists should be included as members of design teams on capital improvement and infrastructure construction projects such that opportunities can be identified and exploited, including the design of standardized elements within the public right of way and streetscape feature lighting (coloured lighting).

Public spaces adjacent to public right-of-ways are opportunities for the inclusion of public art. Given the alleviation of some of the technical restrictions in these spaces, public art expression can have greater impact.



Art Zones

Inclusion of public art in public streetscapes adjacent to private development, should be encouraged in public art policy. Where possible, allowance should be made for the inclusion of public art in the public right-of-way such that artworks on private development can find additional footprint for implementation. Multi-component public artworks which sit on private land, with elements situated on adjacent public lands provide opportunity for greater breadth of artistic expression.

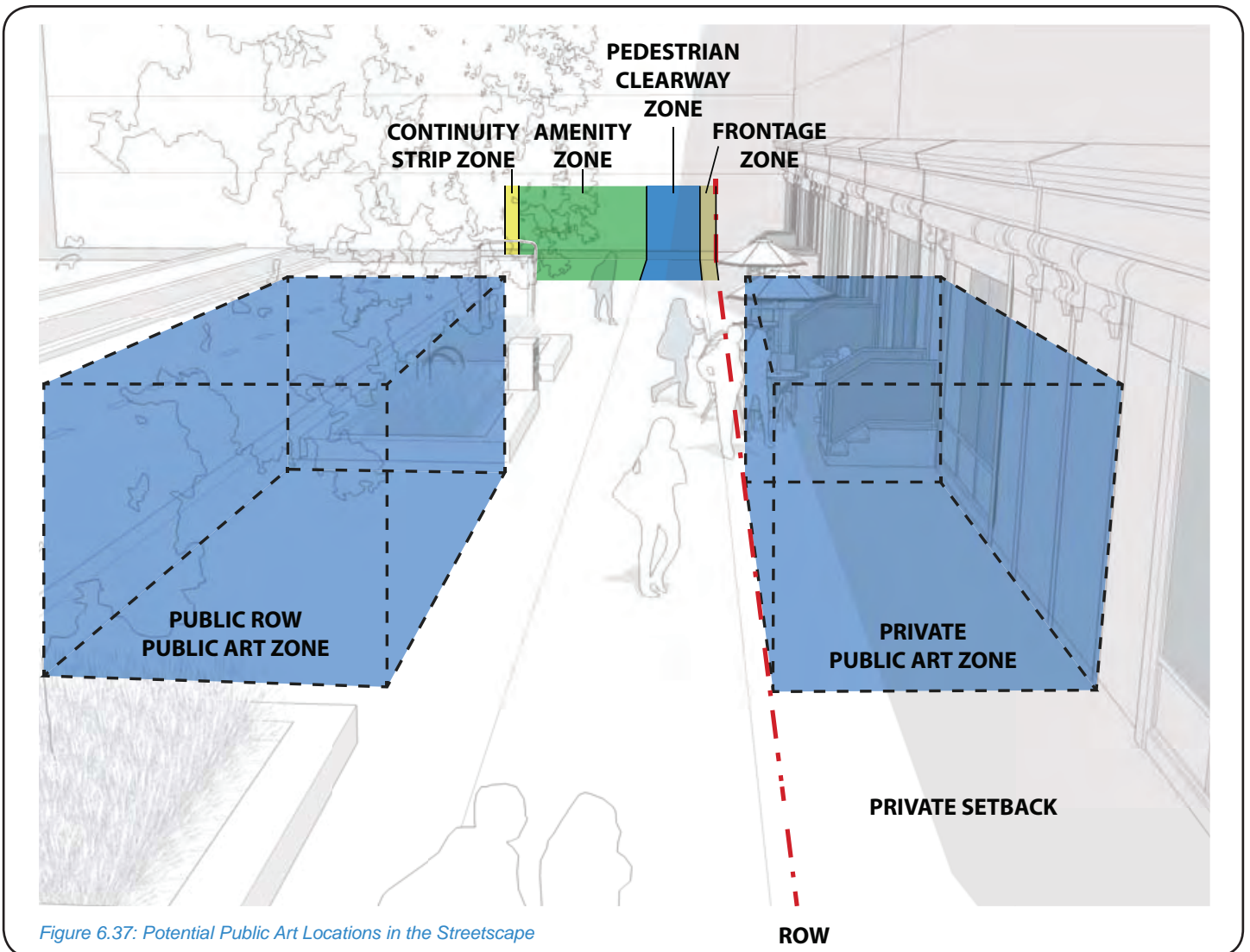
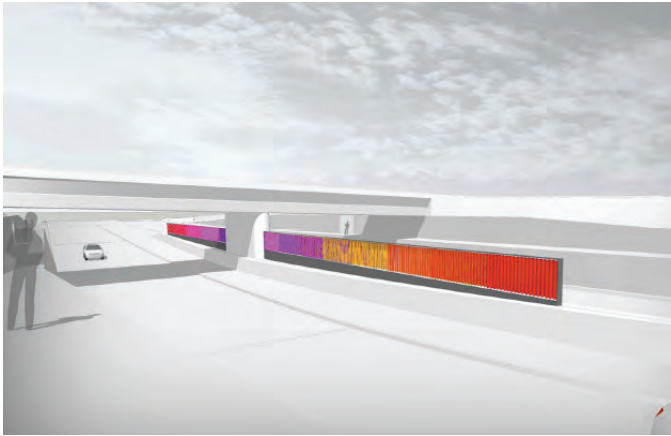

Figure 6.37: Potential Public Art Locations in the Streetscape



Artist: Paul Raff Studio
 An example of a public artwork (proposal) that engages the median space along a public transitway. The artwork is highly visible to pedestrians, public transit users as well as vehicles.



Artist: Jason Bruges Studio
 An example of a public artwork, with minimal footprint, that works at the scale of public infrastructure and is legible to vehicular traffic.



Artist: Jun Kaneko
 Park Avenue, in New York City, through a privately controlled programme, manages exhibits in the median space of the roadway. This is an example of an ongoing, temporary display of public art within the median of a public roadway allowance.



Artist: Pipilloti Rist
 An example of a public artwork, located on private property, adjacent to a public right-of-way that engages the experience of users of the right-of-way.



Artist: Karl Ciesluk
 An example of how public artwork can be implemented in the streetscape right-of-way, within the stringent technical requirements of this zone.



Artist: Brad Golden and Norman Richards
 An example a public artwork whose implementation was scheduled to take advantage of existing plans for capital improvements to the public sidewalk.



Design: Robert Maschke Architects
 An example a streetscape element designed as a component of an artist-led streetscape improvement programme that included seating, planting and paving.